

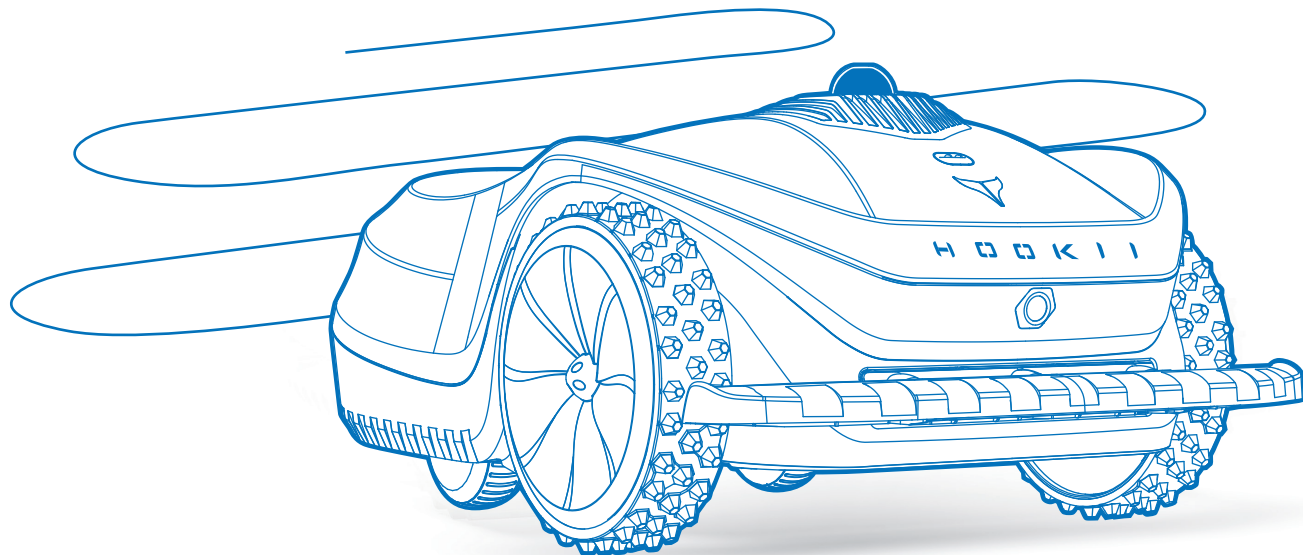

Original Instructions

USER MANUAL NEOMOW X



Before using the product, read the manual carefully to understand the guidance.



Get other language version

If you need a User Manual in other languages, please scan the QR code below to download.

After unboxing, do not discard the packaging box and packaging materials, which can be used for storage in winter or shipment for repair.

PREFACE

Thank you for choosing Neomow X!

Neomow X is an intelligent electric-driven lawn mower based on LiDAR SLAM navigation technology. The mower can automatically help you mow the lawn without any perimeter line by merely installing an App and flexibly using the functions on the App.

You can not only customize lawn care using Neomow X, but also remotely operate and monitor mower operation conveniently through the App, enjoying the fun of carefree mowing and lawn maintenance.

CONTENT

1. Safety Instructions

1.1 General Safety Rules	1
1.2 Precautions For Installation	3
1.3 Precautions For Use	3
1.4 Precautions For Storage	4
1.5 Precautions For Handling	5
1.6 Precautions For Transportation	5

2. Get To Know The Neomow X

2.1 System Introduction	6
2.2 Package List	7
2.3 Neomow X Overview	8
2.4 Symbols And Labels	10

3. Installing Neomow X

3.1 Preparation Before Installation	12
3.2 Installing Charging Station	15
3.3 Charging And Starting The Neomow X	18

4. Using Neomow X

4.1 Getting the App	20
4.2 Adding Devices	20

4.3 Map Creation	21
4.4 Daily Mowing	32
4.5 Other Functions	38
4.6 Obstacle Avoidance	45

5. Acousto-optic Guidance

5.1 Lighting Guidance	46
5.2 Sound Reminder	48

6. Maintenance

6.1 Frequency Of Maintenance	49
6.2 Lawn Mower Cleaning	50
6.3 Replacement Of Consumables	51

7. Specifications

8. Troubleshooting

1.1 General Safety Rules

- (1) Before using the lawn mower, read the manual carefully to understand the instructions. Please keep the manual properly for future reference. The latest complete user manual is available on www.hookii.com.
- (2) Please note that you can reduce risks by following the instructions and warnings in the manual, but you cannot eliminate all risks. The operator or user is responsible for any accidents or hazards that may occur to others and their properties.
- (3) This lawn mower is not suitable for children, or individuals with poor physical or mental condition.
- (4) This lawn mower can only be used together with the devices recommended by HOOKII, and it is incorrect to operate the lawn mower in an unauthorized manner. HOOKII does not guarantee the compatibility of the lawn mower with other wireless systems.
- (5) Do not use this lawn mower when there are children or animals in the work area of the mower.
- (6) Before using this lawn mower on a public lawn, it is required to provide warning signs around the mower's work area, with text reading: Warning, automatic lawn mower! Stay away from the machine and take care of your children.
- (7) Do not touch dangerous parts such as the blade disc and blades before the lawn mower comes to a complete stop.
- (8) If the lawn mower has to be flipped over manually, it must be powered off, and be placed on a soft and dry mat or cloth to prevent damage to components such as the LiDAR.
- (9) No extension cable or cables are allowed in the work area, as they may be damaged. If the extension cable is damaged, cut off the power immediately and contact professional service personnel for replacement and do not touch the cable.
- (10) The battery should be used correctly according to the recommended method in this manual. Only original batteries recommended by HOOKII can be used, and we will not guarantee the safety of non-original batteries. Incorrect use may cause electric shock, overheating, or leakage of corrosive liquid from the battery. If any corrosive liquid comes in contact with the eyes or skin, seek medical attention immediately. The replacement of battery, if necessary, must be carried out in accordance with the instructions and precautions in the manual.

1 SAFETY INSTRUCTIONS

EN

- (11) If the device placed outdoors is exposed to a thunderstorm, it is advisable to power off the device and charging station to prevent device damage and accidents.
- (12) How to move the lawn mower
- 1) Press the STOP button on the mower.
 - 2) Lift the mower with both hands from the front and back side. Do not directly raise the front bumper.

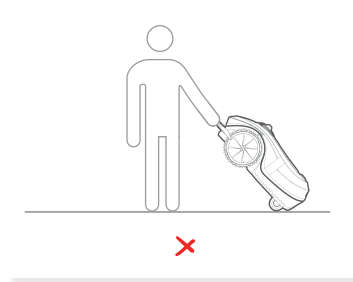
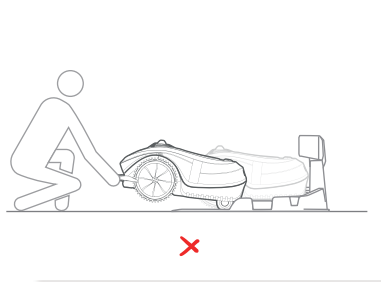
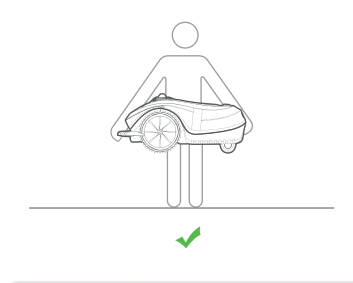
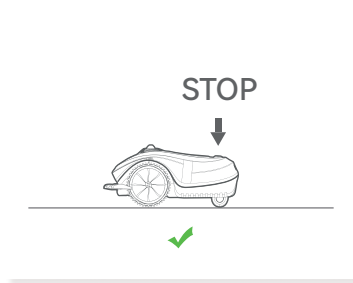

1.2 Precautions For Installation

- (1) To avoid fire risks, do not install the charging station and device, including all other accessories, within a distance of 1 meter from combustible materials.
- (2) To reduce the risk of damage to the power adapter and avoid electric shocks, do not place the power supply on the ground or in any other location that may be exposed to water.
- (3) To prevent damage to the power supply system and reduce the risk of electric shock due to condensation, the power supply should be encapsulated.
- (4) To ensure electrical safety, the charging station must be supplied by household power instead of the industrial power.

1.3 Precautions For Use

- (1) When the lawn mower is working, keep people a certain distance from the lawn mower and do not put the hands or feet near or below the lawn mower.
- (2) When someone stays in the work area of the lawn mower, power off or stop the lawn mower. It is advisable to work when there are no people or animals around.
- (3) To avoid interruptions due to water ingress in the lawn mower, it is not advisable to operate the lawn mower when the water sprinkler in the work area is not working.
- (4) Ensure that there are no stones, branches, tools, or other large objects on the lawn, since collision with such objects may cause blade damage, resulting in property loss.
- (5) To avoid work interruption due to abnormal state, do not lift or flip the lawn mower when it is turned on.
- (6) If the red STOP button on the lawn mower does not work, do not use the device until the STOP button returns to normal.
- (7) The suitable operating temperature for the lawn mower and battery is 0–40°C (32–104 °F) and 0–40°C (32–104°F), respectively. Never operate in an environment beyond the appropriate range.

1.4 Precautions For Storage

Battery Storage :

- (1) The battery is preferably stored at $-20-45^{\circ}\text{C}$ ($-4-113^{\circ}\text{F}$), recommended $0-45^{\circ}\text{C}$ ($32-113^{\circ}\text{F}$), and must not be stored in an environment beyond the appropriate range.
- (2) The battery should be stored indoors in a cool and dry place, because a humid environment will accelerate battery aging.

Mower Storage :

- (1) Before you decide to put away the lawn mower for a period of time, you need to fully charge the machine to avoid over-discharge, and turn off the lawn mower. Remove the battery and store it separately.
- (2) If the lawn mower needs to be stored for a long time, the lawn mower should be fully charged once within six months.
- (3) During storage, the lawn mower should be placed flat, with four wheels on the ground horizontally.
- (4) To store the charging station indoors, cut off the power supply and disconnect all connectors on the charging station.
- (5) The lawn mower should be preferably stored at $-20-45^{\circ}\text{C}$ ($-4-113^{\circ}\text{F}$), recommended $0-35^{\circ}\text{C}$ ($32-95^{\circ}\text{F}$), and must not be stored in an environment beyond the appropriate range.
- (6) The lawn mower should be stored indoors in a cool and dry place, since exposure to sunlight and extreme temperature (including high and low temperatures) will accelerate component aging and may cause permanent damage to the battery. During storage, the components of lawn mower should be kept away from heat sources or chemicals.
- (7) To achieve optimal charging efficiency and avoid charging interference after storage in the winter, it is required to power off, and clean the charging contacts on the lawn mower and charging station with a cotton cloth.

1.5 Precautions For Handling

- ① Battery handling must comply with the recycling requirements and relevant regulations in your region.
- ② The battery shall be replaced according to the operating instructions in this manual. Lithium battery may explode or cause a fire when it is disassembled, short circuited, exposed to water, fire, or high temperature. The battery must be handled with care, and must not be disassembled, opened, or used for any other type of electrical/mechanical device. Prolonged exposure to direct sunlight should be avoided.

1.6 Precautions For Transportation

- ① Comply with all applicable national regulations.
- ② Comply with the special requirements of packaging and labeling for commercial transportation, including transportation by third parties and freight forwarders.

2.1 System Introduction

The system includes a lawn mower, a charging station, and an App. Based on LiDAR SLAM technology, the lawn mower realizes autonomous navigation and positioning without boundary lines within the lawn. The lawn mower has to establish a map in advance, and compare real-time environmental sensing data using LiDAR during operation, in order to calculate the precise position of the lawn mower. The charging station is mainly used to power the lawn mower.

The lawn mower needs to be used in conjunction with the Neomow App which helps control the lawn mower to create information about lawn boundary and assigns customized tasks to the lawn mower for independently mowing. Moreover, various mowing parameters can be set to meet the personalized mowing needs of users.

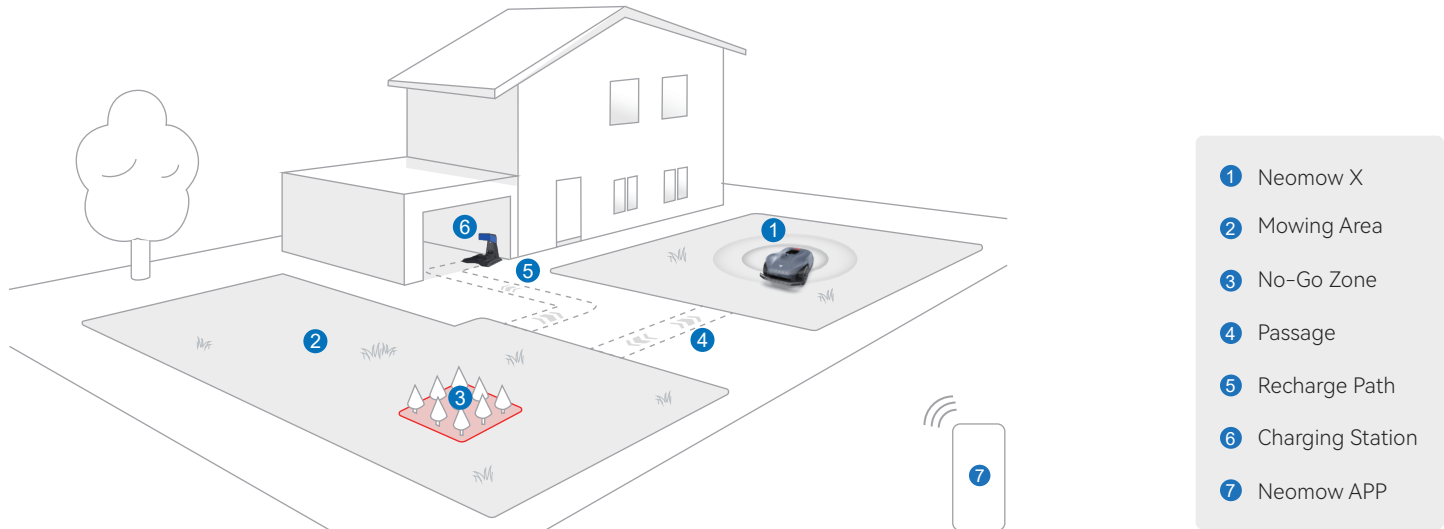

2 GET TO KNOW THE NEOMOW X

EN

2.2 Package List

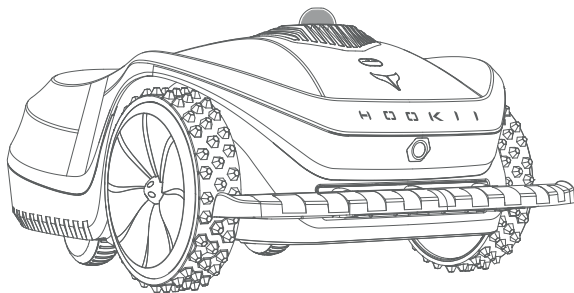

Neomow X *1

Charging Station * 1

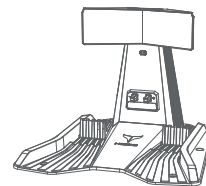

Spare Blade Kit * 2
(10 Screws+10 Blades)



Warranty Card * 1



Fixed Charging Station Tape * 4



Power Adapter * 1

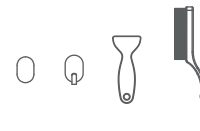

Cleaning Kit * 1



User Manual * 1



Quick Start Guide * 1



Fixed Charging Station Nail * 12



Hex Key * 1

2.3 Neomow X Overview

Top View

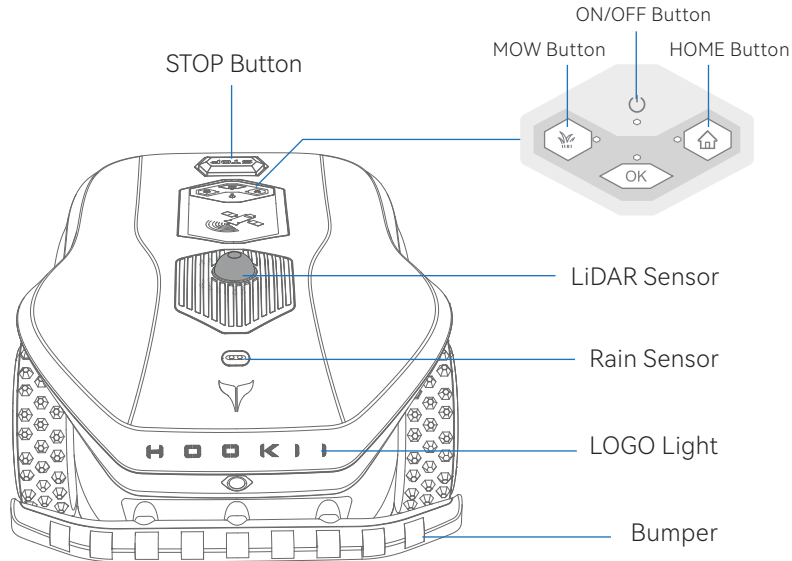

Back View

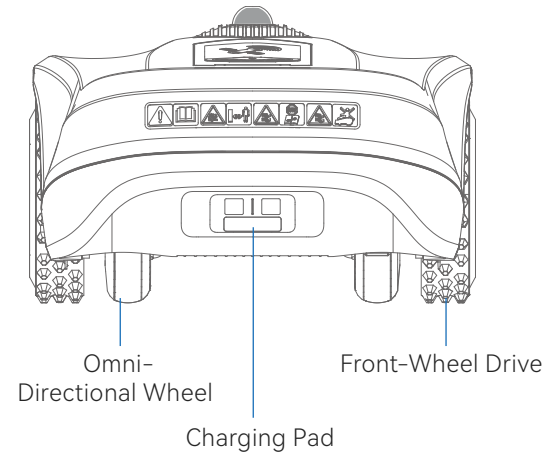

2 GET TO KNOW THE NEOMOW X

EN

Bottom View

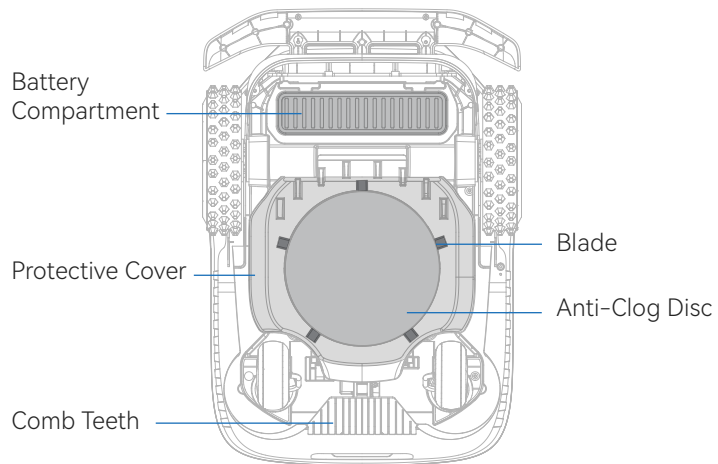

Charging Station Overview

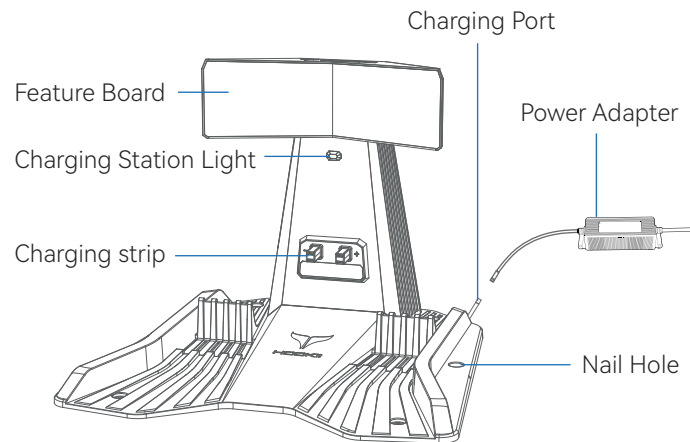

2.4 Symbols And Labels

Introduction To Lawn Mower Symbols/labels



WARNING: Read the user manual before operating the lawn mower.



WARNING: Disable the lawn mower before working on or lifting the machine. Never touch the rotating blade.



WARNING: Keep a safe distance from the machine when operating. Keep other persons out of the danger area.



WARNING: Do not ride on the machine.



Use a detachable power supply as defined on the rating label next to the symbol.



Sound power level, determined by European outdoor noise directive.



It is not permitted to dispose this lawn mower as normal household waste. Ensure that the lawn mower is recycled in accordance with local legal requirements.



CE conformity mark.



Class III



DC

Introduction To Charging Station Symbols/labels



Read the user instructions.



Replace with fuse in accordance with rating.



Replace with fuse in accordance with rating.



Class II construction.



Do not discarded as unsorted waste but must be sent to separate collection facilities for recovery and recycling in accordance with local legal requirements.

Introduction To Battery Symbols/labels



Do not discard the battery into fire and do not expose the battery to a heat source.



Do not immerse the battery into water.



Recyclable mark.

Li-Ion



It is not permitted to dispose the battery pack as normal household waste. Ensure that the battery pack is recycled in accordance with local legal requirements.

Li-Ion

3.1 Preparation Before Installation

Lawn Pre-cleaning

- ① First, draw a sketch of your courtyard and mark the location of charging station, work area, passage, recharge path, and No-Go zone on the sketch for future reference.

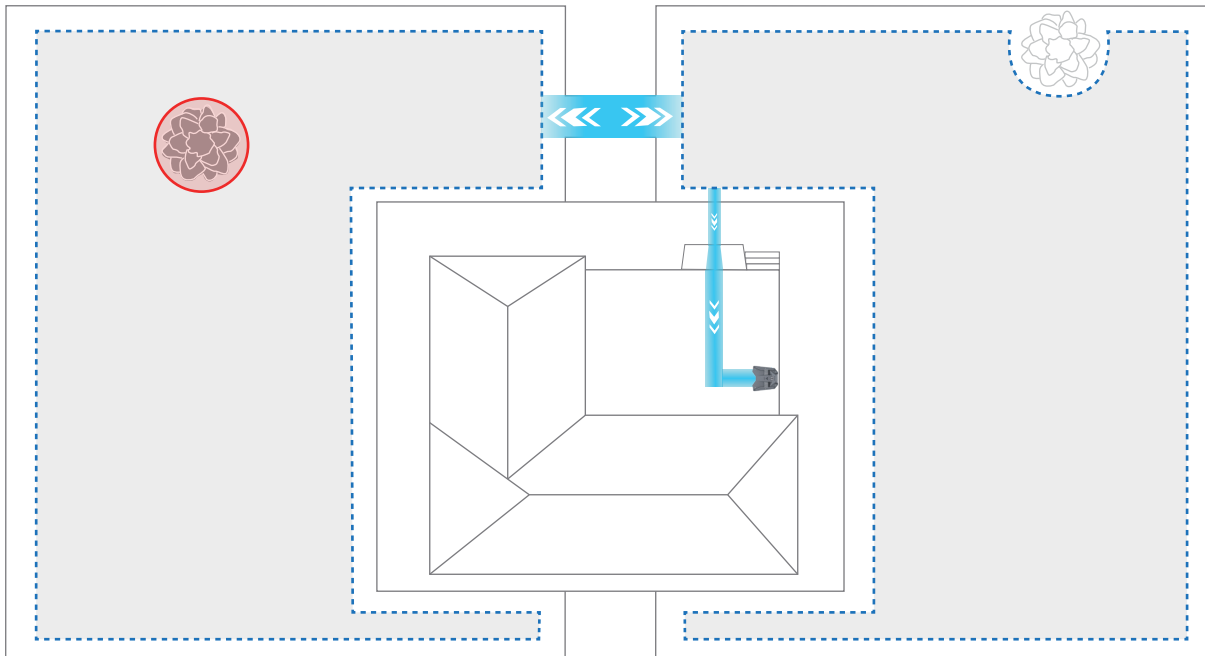

3 INSTALLING NEOMOW X

EN

- (2) Clean up debris on the lawn, such as branches, toys, wires, stones, and other obstacles.
- (3) Fill in the pits on the lawn and level the lawn.
- (4) Before using the lawn mower, trim your lawn until the lawn height is ≤ 10 cm/4 in.

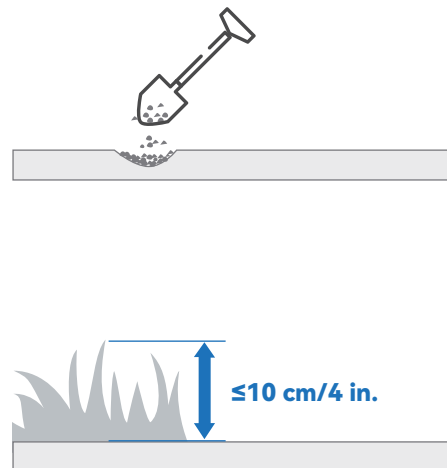
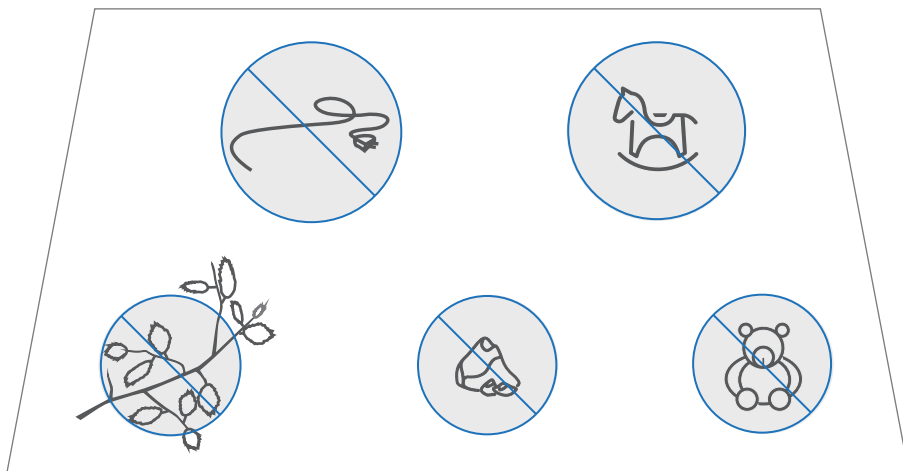

Inappropriate Working Scenarios:

- (1) Areas in the lawn with a slope greater than 45% (24°).
- (2) A scenario where the lawn is too open and lacks any features (definition of an open space: there is no any features in an area with a radius of 25m centered on a LiDAR).
- (3) It is not advisable to delineate a mowing area in any narrow area with width less than 1.5m within the lawn.
- (4) The obstacles with reflective materials on the lawn, such as glass and mirrors, will affect the operation of the LiDAR. It is advisable to apply a film to the reflective surface of the obstacle that cannot be removed.

1

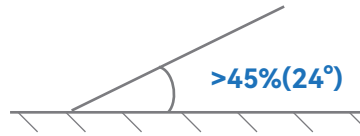

X

2

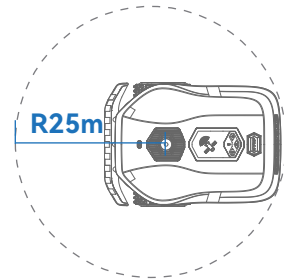

X

3

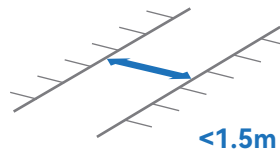

X

4



X

3.2 Installing Charging Station

Choose A Suitable Installation Location

- (1) Ensure that the charging station, when installed on a site, is provided with an unobstructed space of 0.5m on both sides and 2m in front, and the charging station should also be provided with a gentle space of 1.5m around and 2m in front, with a tilt angle of less than 5° .

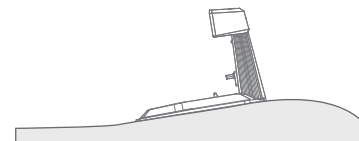
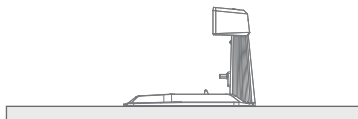
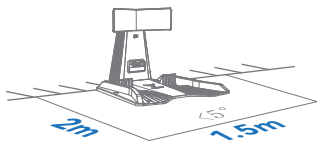
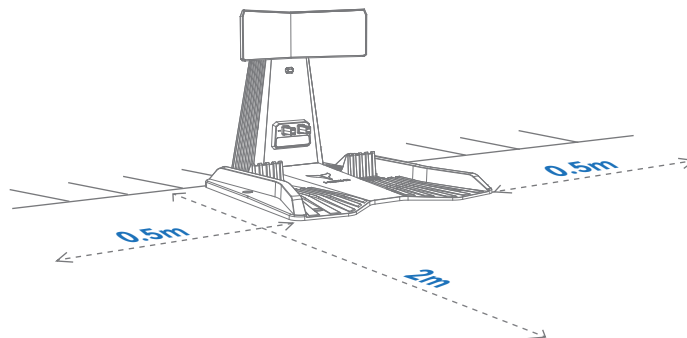

- (2) It is necessary to maintain a distance of 20cm between the charging station and the wall when the charging station is installed against the wall.

Installing The Charging Station

- (1) Place the charging station in the selected installation location and connect the power port of the charging station to the power adapter cable. If it is necessary to connect an extension cable, connect power port to the extension cable first, and then connect the power adapter.

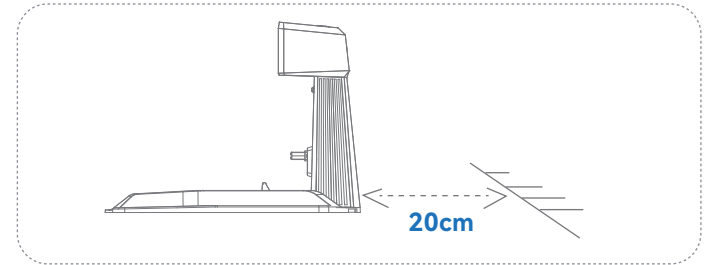
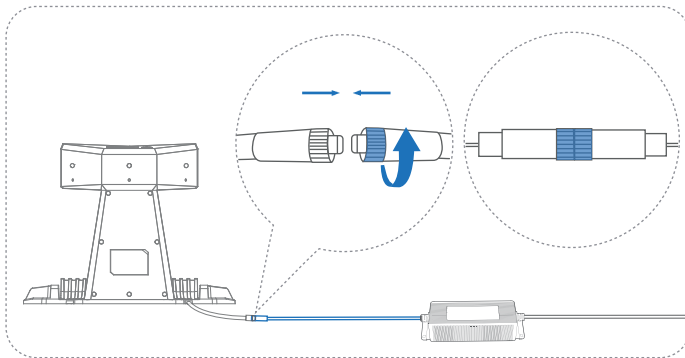

- (2) Insert power plug into a suitable power outlet, and then the power indicator light on the charging station will light up.

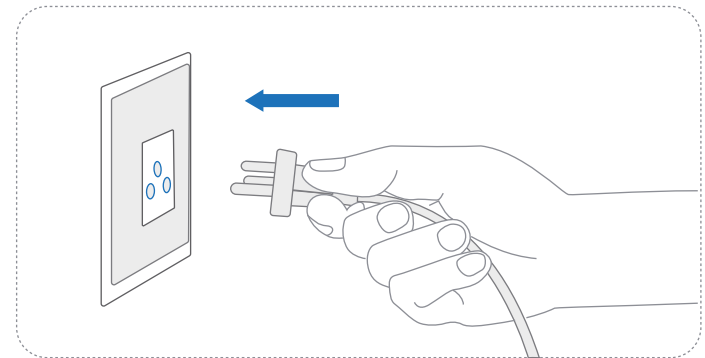

3 INSTALLING NEOMOW X

EN

3) Fix the charging station. The fixing method may vary since Neomow X can be installed on a variety of sites:

1) Install on a lawn

Use the provided ground nails to secure the charging station and fix the extension cable.



CAUTION: When fixing the cable, straighten it directly along the ground.

2) Install Indoors

Fix the charging station on a flat, clean and hard indoor ground using the tape provided in the package, and then fix the cables.

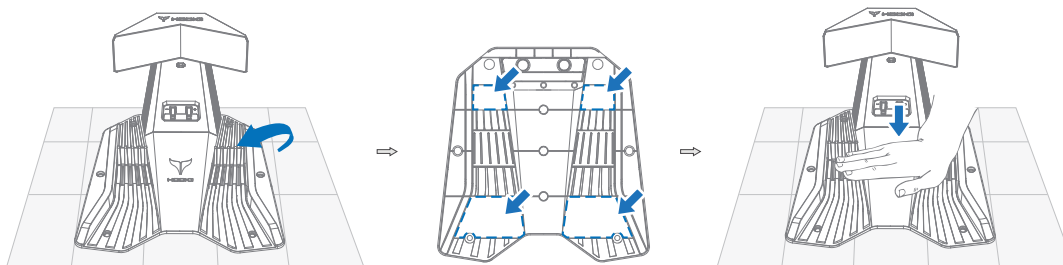

3 INSTALLING NEOMOW X

EN

CAUTION:

- (1) After the charging station is installed, do not move the charging station beyond a range of 20cm.
- (2) If you need to add additional fender to the charging station, note that the cover should be greater than 47cm in height and 77cm in width.

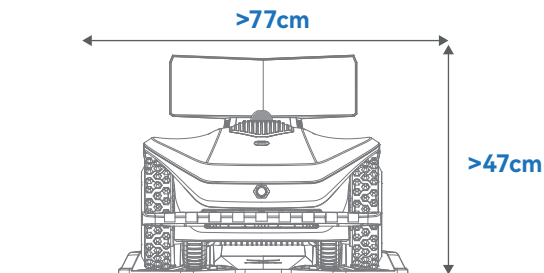

3.3 Charging And Starting The Neomow X

How To Charge ?

(1) First Charging

The lawn mower may have a low battery level after a long-time storage, and should be fully charged before first use. The lawn mower should be placed into the charging station to ensure that the charging pad on the lawn mower is in good contact with the charging strip on the charging station, and the charging indicator light on the charging station will light up.

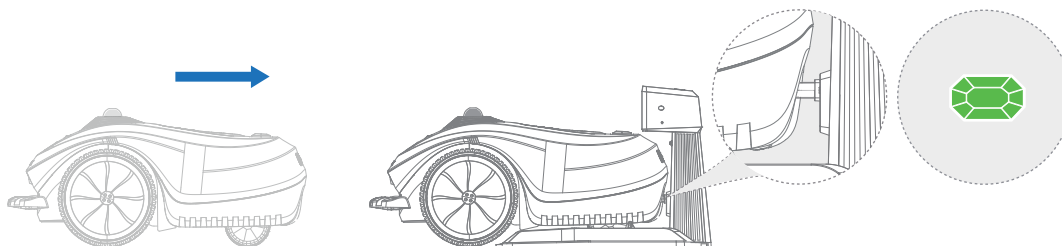

(2) Automatic Charging

After a map is created on the App, if the lawn mower has the battery level below the set low battery threshold (<20%) during operation, it will automatically return to the charging station for charging.

You can also send a recharge task to the lawn mower by pressing the HOME+OK button on the body or the recharge button on the App.

WARNING:

- (1) Do not charge if the lawn mower, power supply, charging station, or power outlet is damaged.
- (2) Do not charge the lawn mower when the temperature is above 40°C (104 °F) or below 0 °C (32 °F).
- (3) The battery has a temperature protection mechanism, so that if the battery' s internal temperature exceeds its allowed limit temperature for charging, the lawn mower will return to the charging station and will not charge until the temperature drops to a safe threshold. If the internal temperature of the battery exceeds the allowable discharge limit temperature, the lawn mower will stop mowing and return to the charging station until the temperature drops to a safe threshold.
- (4) In case of abnormal odor or sound, stop charging immediately and contact the after-sales service department.
- (5) Keep away from flammable and explosive materials during charging.

Turn on Neomow X

Press and hold the ON/OFF button on the lawn mower to automatically start. The HOOKII light turns blue intermittently during startup, and will remain blue after the startup is completed. The lawn mower then can be used normally.

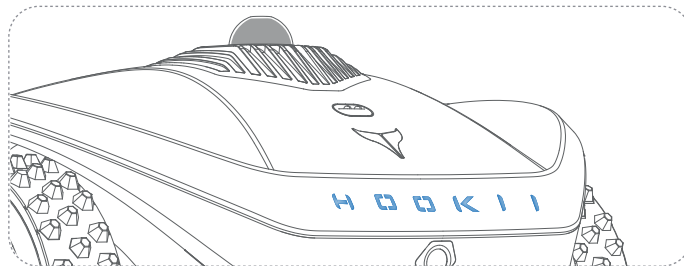
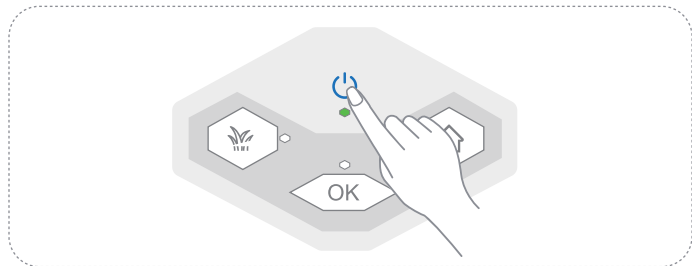

4.1 Getting the App



The App, an essential part of a complete experience of lawn mower, should be installed before the use of lawn mower. To ensure successful installation, please scan the QR code to enter the App market and download Neomow App for installation. Register and log in after App installation.

Note:

- (1) During use, the App will, when necessary, use your Bluetooth, GPS positioning, and WiFi. To ensure normal use, you are advised to allow the use of the above functions according to the App prompts.
- (2) The following diagram about the App is for illustration only, and the App page will change along with the continual optimization of the software version.

4.2 Adding Devices

- (1) Open the App, add a device for the current account, and enable Bluetooth and positioning on your phone.
- (2) Add devices via Bluetooth according to the App's instructions. During device addition, keep your phone as close as possible to successfully search for and add the lawn mower.

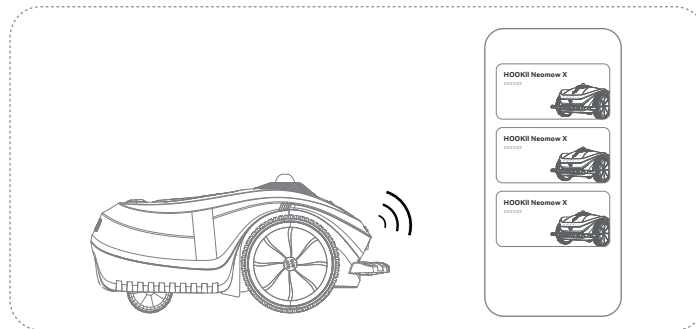
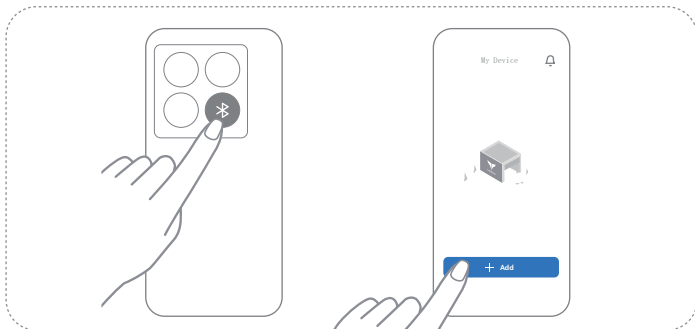

- (3) Select the connection method. The lawn mower can be connected by a phone in two ways: 4G connection and WiFi connection. When the lawn mower is connected without setting up WiFi connection, 4G connection will be enabled by default. If you want to connect the lawn mower via WiFi, you can set the WiFi name and password on the App to connect the lawn mower to your household WiFi. After setup is finished, the lawn mower will access the internet through WiFi by default.

4.3 Map Creation

- (1) The map consists of four map elements: mowing area, passage, No-Go zone, and recharge path.
- (2) The mowing area is used to delineate the boundary of work area of lawn mower, the passage is used to connect two mowing areas, and the No-Go zone is used to delineate inaccessible areas within the mowing area, for example, the obstacles such as trees, fixed tables and chairs. The recharge path is used to delineate a path for the lawn mower to return to the charging station from the mowing area.

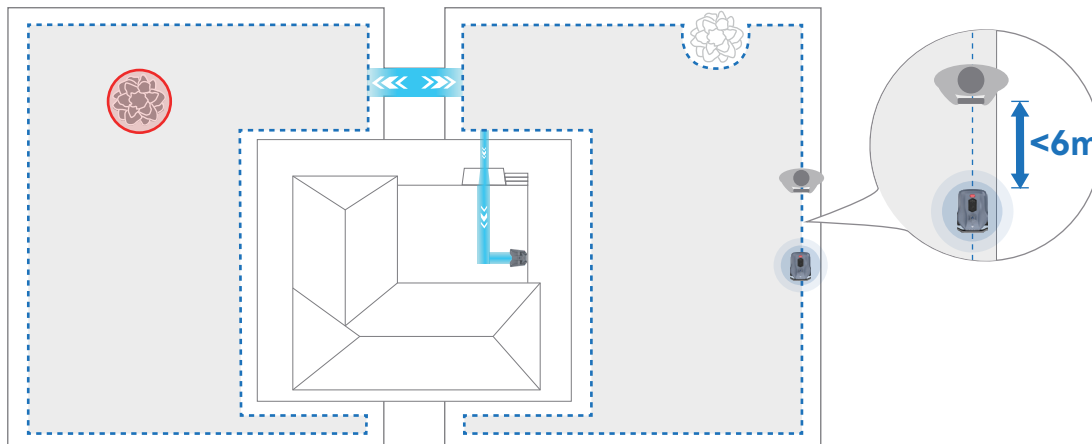

Caution:

- (1) To ensure the mapping accuracy and security, Bluetooth connection is required during map creation and management. It is advisable that the operator should be less than 6m away from the machine throughout the entire process.
- (2) Before mapping, charge in advance to ensure that your phone and lawn mower have sufficient battery life.
- (3) During mapping, avoid Bluetooth disconnection because either the phone or machine is too close to large obstacles such as trees, high walls, houses, etc.
- (4) It is not advisable to map on rainy days, as raindrops on the LiDAR may hinder its recognition of surrounding locations.

Creation And Limitation Of Mowing Area

The mowing area delineates the actual mowing area of the lawn mower.

- (1) Select mowing area on the Map Management page and start mapping.

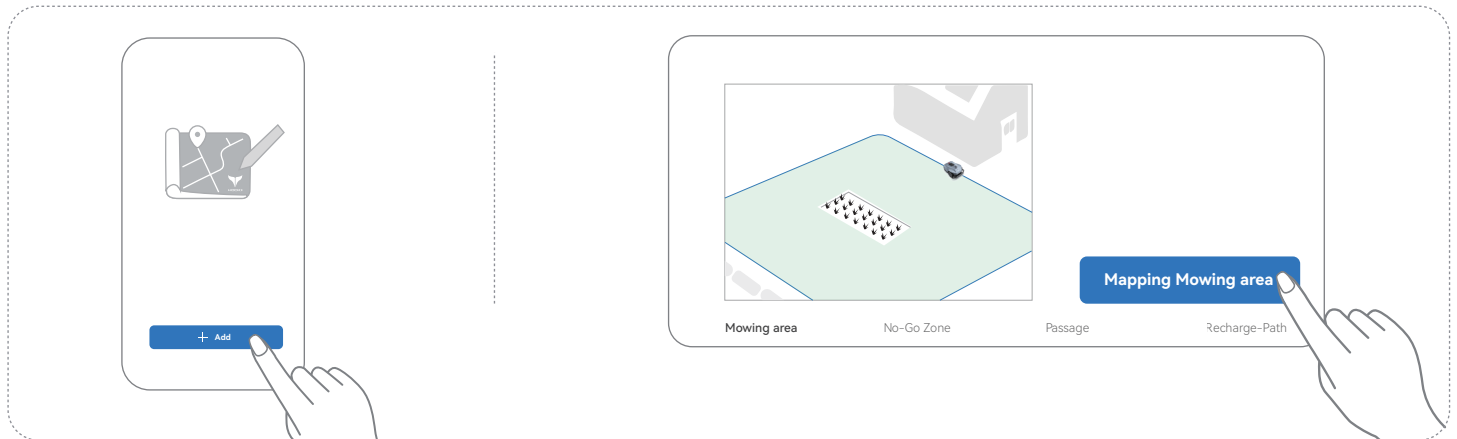

- (2) Find a suitable starting point at the edge of the lawn, and during mapping, the distance between the person and lawn mower should be less than 6m.

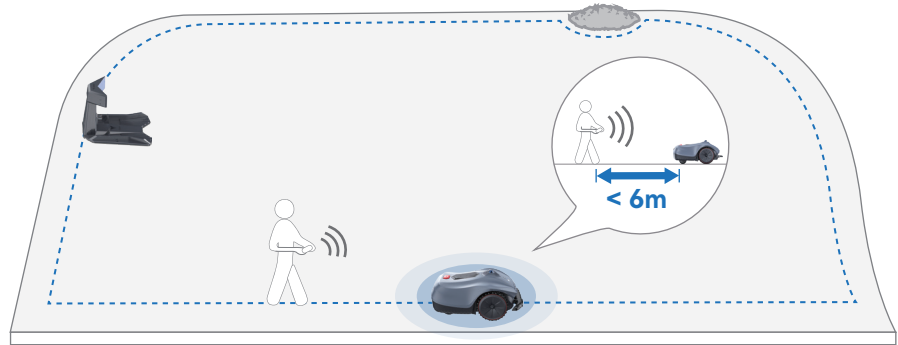

- (3) Remotely control the lawn mower, walk along the boundary of mowing area and delineate the boundary line based on the following situations:

- 1) If the difference in elevation between the areas within and outside the lawn boundary is less than or equal to 1 cm, it's advisable to maneuver the mower slightly beyond the boundary to delineate a neat border, which will facilitate a complete trimming along the entire lawn boundary.



- 2) In the presence of obstacles such as a wall or fence that notably varies in height from the lawn level, it's advisable to keep the mower at least 5 cm away from the lawn border while defining the boundary. This practice minimizes the risk of collision and potential damage to the mower during turning maneuvers.

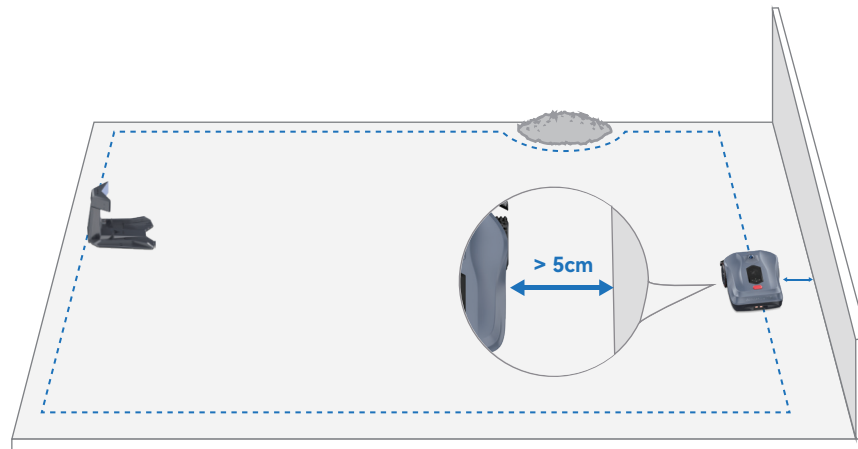

- 3) In instances where your lawn sits elevated above the ground level with a significant drop-off at its boundary, it's recommended to establish the border at a distance greater than 10 cm from the lawn boundary, thereby prevent the mower from falling over the boundary.

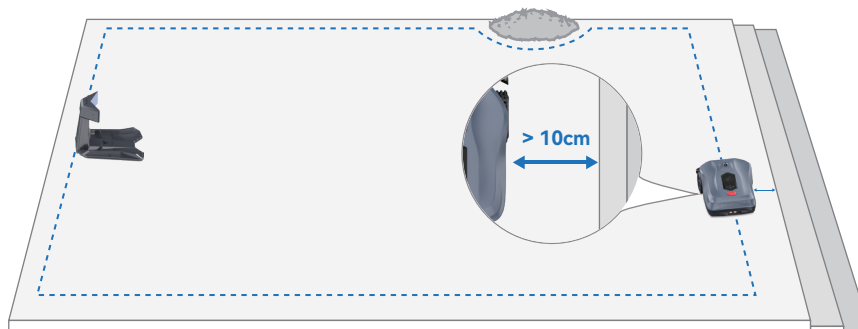

- (4) Remotely control the lawn mower to the starting point and end the mapping. If you have a number of separate lawns, repeat this step.

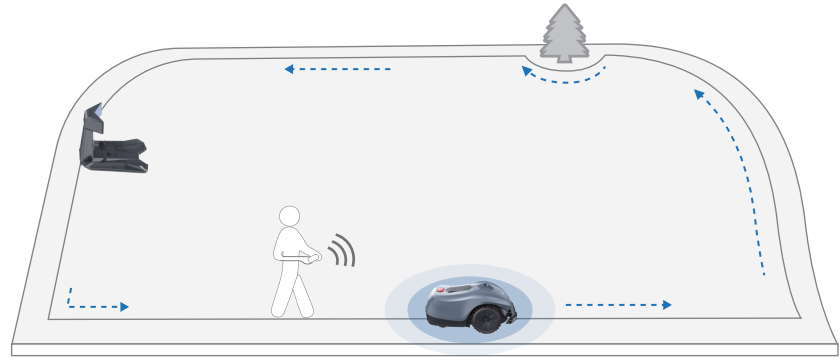

CAUTION:

- (1) When you remotely control the lawn mower to a place where turning is required, maintain the lawn mower at a turning angle greater than 90° .
- (2) When mapping a mowing area, maintain the width of mowing area greater than 1.5m, and it is not advisable to delineate a mowing area in a lawn with a width below 1.5m, as the mower may not run smoothly.

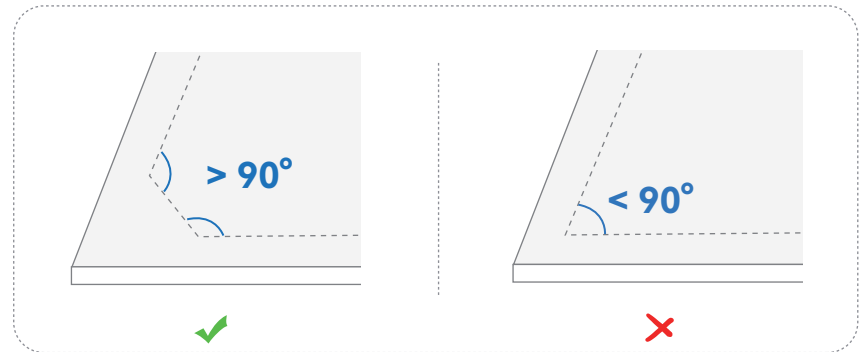

Creation And Limitation Of No-Go zones

When colliding with an obstacle, the lawn mower will move back appropriately and change direction to stay away from the obstacles. We suggest defining a No-Go zone to protect existing objects in the mowing area that we don't want the lawn mower to collide with, such as trees, flower beds, lawn decorations, swimming pools, sprinklers, fixed tables and chairs.

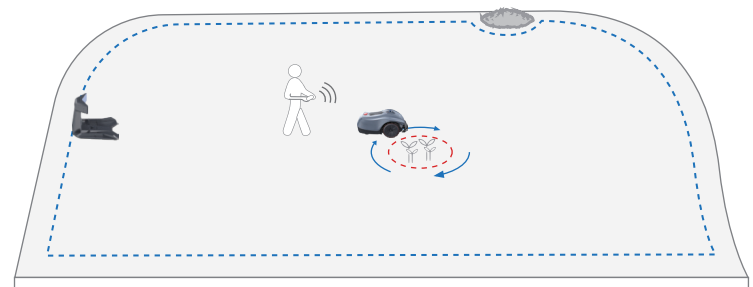
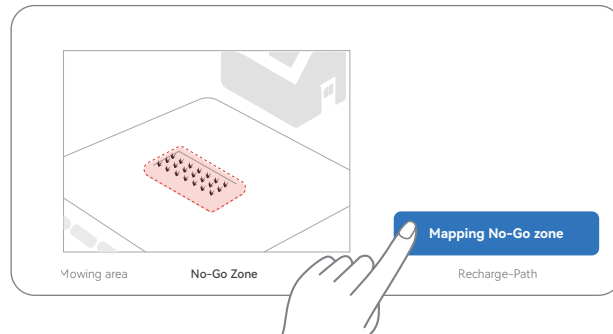

CAUTION:

- (1) It is advisable to prioritize the creation of No-Go zone prior to the passage and recharge path.
- (2) To ensure the smooth running of lawn mower, it is advisable to maintain a certain distance between the No-Go zone and the passage or recharge path. If the obstacles cannot be removed and the lawn mower is unable to pass due to the close proximity of obstacles with the passage or recharge path, it is advisable to remap the recharge path or passage.
- (3) The No-Go zone on the App can be deleted when you remove fixed obstacles on the lawn and no longer need the No-Go zone.
- (4) A distance of 5cm or more must always be maintained from the obstacles when a No-Go zone is mapped around obstacles.
- (5) We suggest delineating the two fixed obstacles with a spacing less than 1m in the same No-Go zone.

Creation And Limitation Of Passage

If at least two separate mowing areas are created in your yard and you want to set up a passage for the mower, you can create a passage.

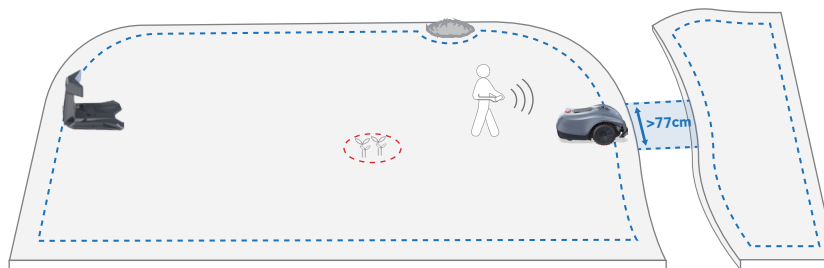
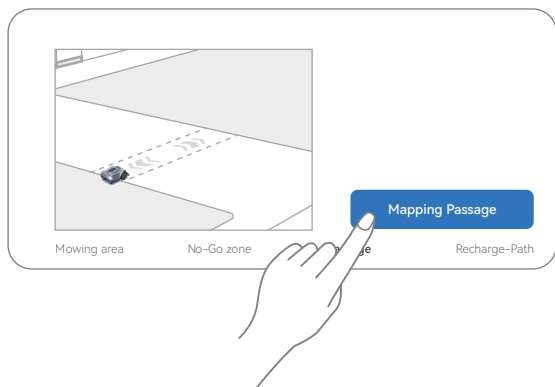

CAUTION:

- (1) We should choose a passage that allows the lawn mower to pass smoothly. When creating a passage, we should cause the lawn mower move along the centerline of the passage as much as possible, avoiding deviation from the passage during subsequent operation.
- (2) The flat and dry ground should be selected as a passage, and the lawn mower can run and turn around smoothly in an unobstructed passage with a minimum width of 77cm. In case there is a height difference of more than 3cm along the entire route, we suggest choosing another one as the passage to prevent the mower from getting stuck during operation.
- (3) The passage's starting point must be located within or at the boundary of two mowing areas.

- (4) To ensure the smooth running of lawn mower, it is advisable to maintain a certain distance between the No-Go zone and the passage or recharge path. If the obstacles cannot be removed and the lawn mower is unable to pass due to the close proximity of obstacles with the passage or recharge path, it is advisable to remap the recharge path or passage.
- (5) If separate mowing is required for the same lawn, for example, your lawn is divided into two areas of different grass species, it is advisable that you define two adjacent mowing areas in the same lawn without passage connection, and the two mowing areas can be appropriately overlapped.

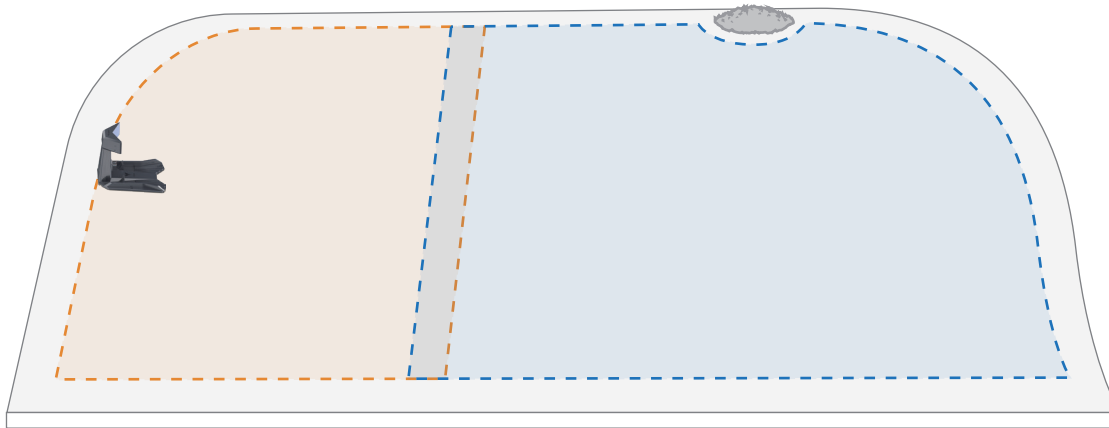

Creation And Limitation Of Recharge Path

This lawn mower's charging station can be placed indoors to extend the service life of the lawn mower and charging station. If the lawn mower is not deployed within the boundary of mowing area, it is advisable to set a recharge path to help the lawn mower return to the charging station accurately.

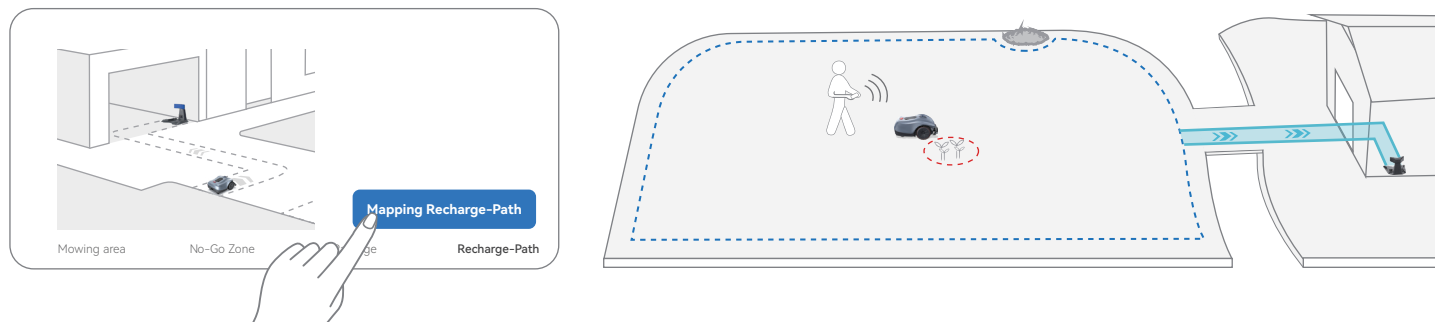

CAUTION:

- (1) It is advisable to map the recharge path from the boundary point of mowing area closest to the charging station, which can help the lawn mower effectively return to the recharge station.
- (2) The lawn mower can smoothly enter and exit the charging station on an unobstructed recharge path with a minimum width of 77cm.
- (3) To ensure the smooth running of lawn mower, it is advisable to maintain a certain distance between the No-Go zone and the passage or recharge path. If the obstacles cannot be removed and the lawn mower is unable to pass due to the close proximity of obstacles with the passage or recharge path, it is advisable to remap the recharge path or passage.

- (4) When mapping a recharge path, ensure the mower enter the charging station from 1m in front as much as possible.

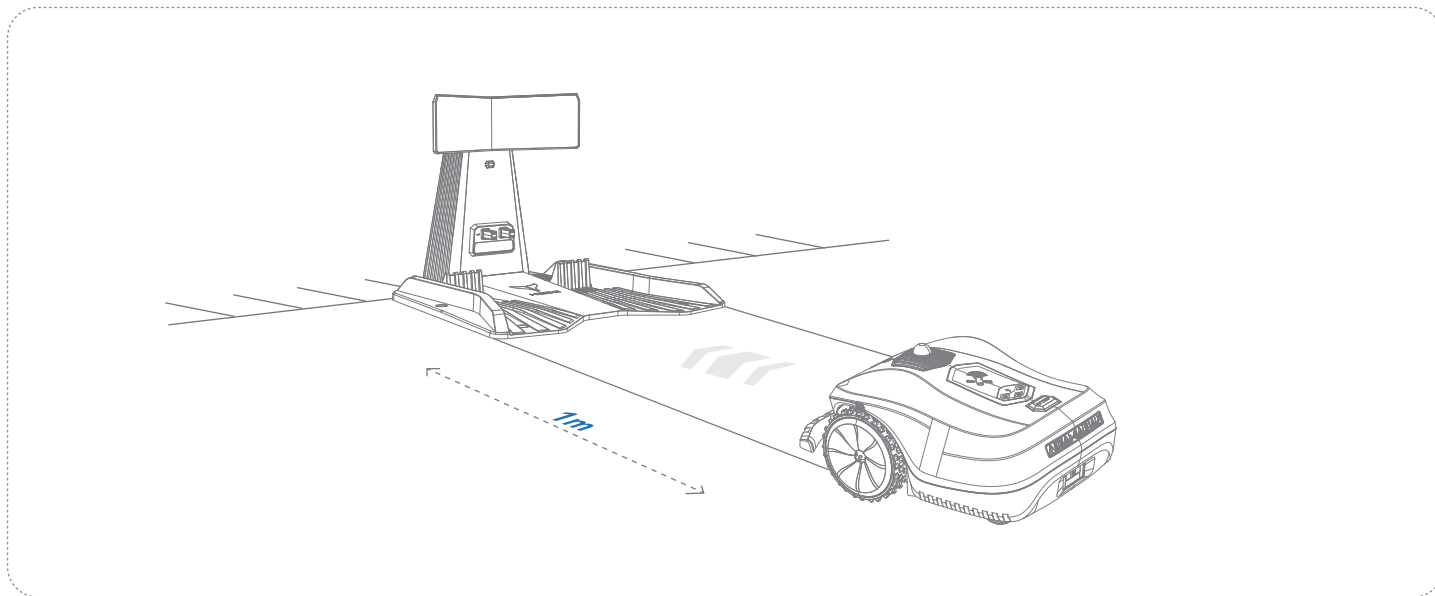

Undo

If the lawn mower takes a wrong path under remote control when you are creating an area, it is advisable to erase the path through undo operation when you attempt to erase the wrong part and map again.

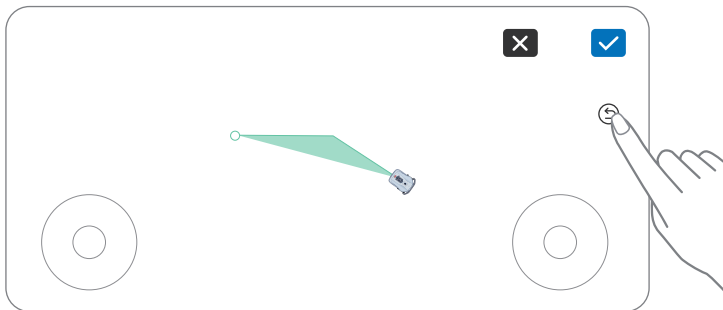

Map Modification

If you attempt to make tiny boundary modification to a newly created region, for example, increasing the area of your lawn/No-Go zone, it is advisable to modify the boundary of the region through map modification.

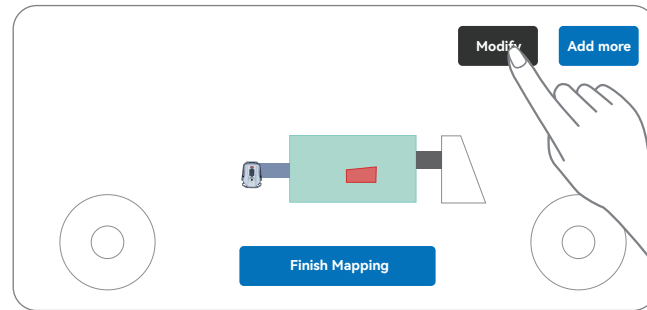

CAUTION:

- (1) Map modification is only applicable to tiny boundary modification, and it is advisable to create the area again if a major boundary modification is required.
- (2) The distance between the starting point and ending point of the modified line segment should be greater than 1m.

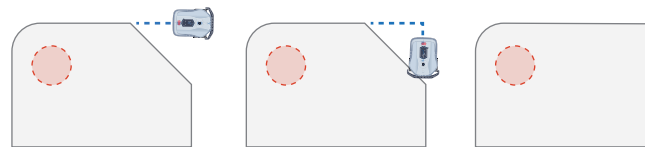

4.4 Daily Mowing

This section mainly introduces how the lawn mower automatically mows and how to operate the lawn mower, for example, starting and pausing mowing, returning to charging station, and resolving abnormalities.

CAUTION:

- (1) To perform automatic mowing, work out a mowing map in advance on the App.
- (2) To perform mowing at scheduled time, set a scheduled task for the lawn mower on the App.

Introduction To Mowing Path

After mapping is finished, the lawn mower will automatically plan the most efficient mowing path, and start efficient mowing along the well-planned path. After mowing the grass inside the lawn, the lawn mower starts mowing along the boundary of the mowing area, and returns to the charging station after finishing the operations in all mowing areas.

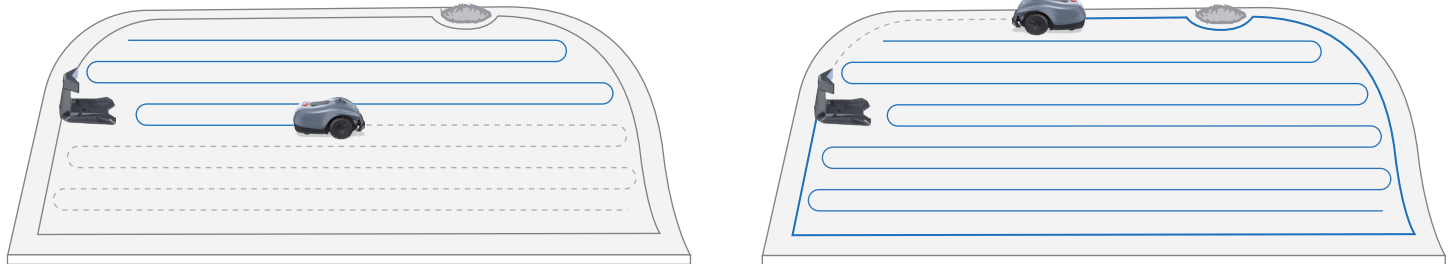

CAUTION:

- (1) The lawn mower with a low battery will stop mowing and automatically return to the charging station for charging and, after being fully charged, will automatically return to the previous location for lawn mowing.
- (2) You can view in real time the mowing progress on the App.

Start Mowing

(1) Click the Start button on the App.

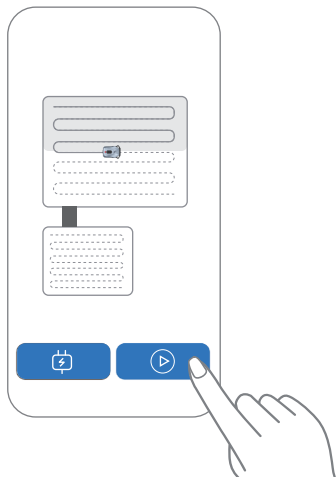

(2) On the lawn mower's button panel, press the Mow +OK button in sequence

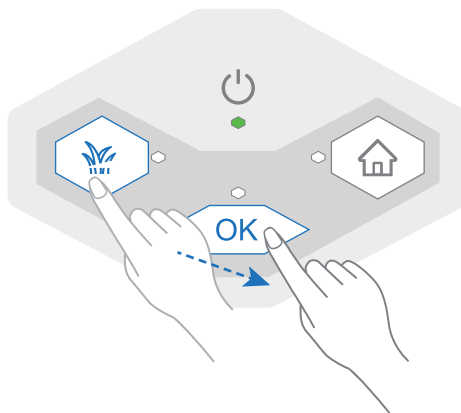

(3) If a mowing schedule is set in advance, the lawn mower will mow at the scheduled time.

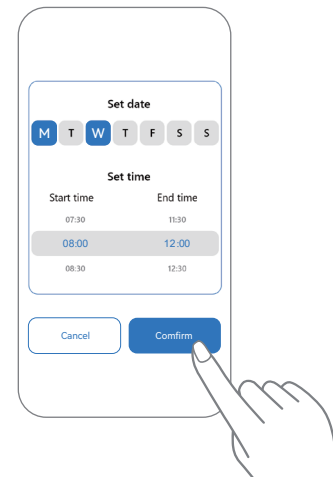

Pause Mowing

Press the red button STOP on the button panel of lawn mower, or click the Pause button on the App.

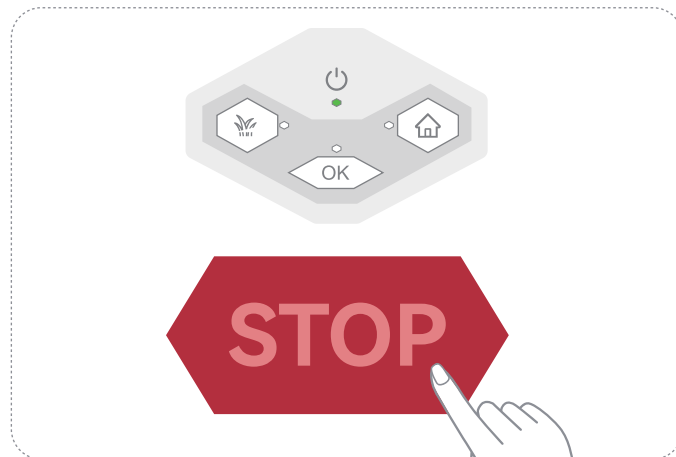
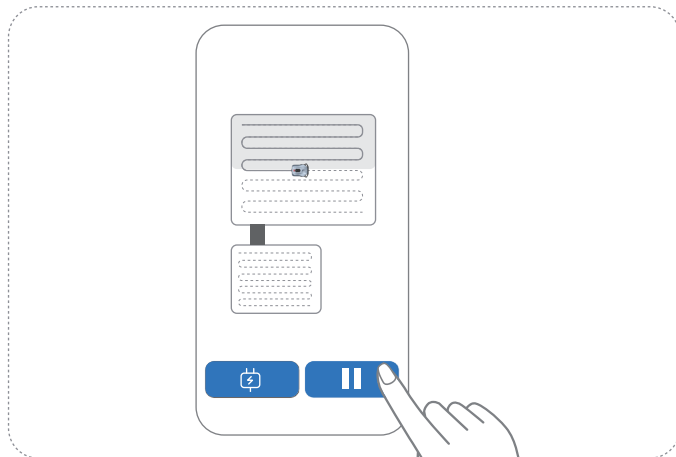

CAUTION:

- (1) It is required to perform the following operations if you attempt to start mowing immediately after pressing the STOP button on the lawn mower:
 - 1) Short press OK button to release the emergency stop state;
 - 2) Click on Start button on the App, or press Mow +OK on the mower in sequence.
- (2) It is required to perform the following operations if you attempt to return the mower to the charging station immediately after pressing the STOP button on the lawn mower:
 - 1) Short press OK button to release the emergency stop state;
 - 2) Click Home button on the App, or press HOME+OK on the mower in sequence.

Continuing Mowing

Press Mow+OK on the button panel of lawn mower, or click the Start button on the App.

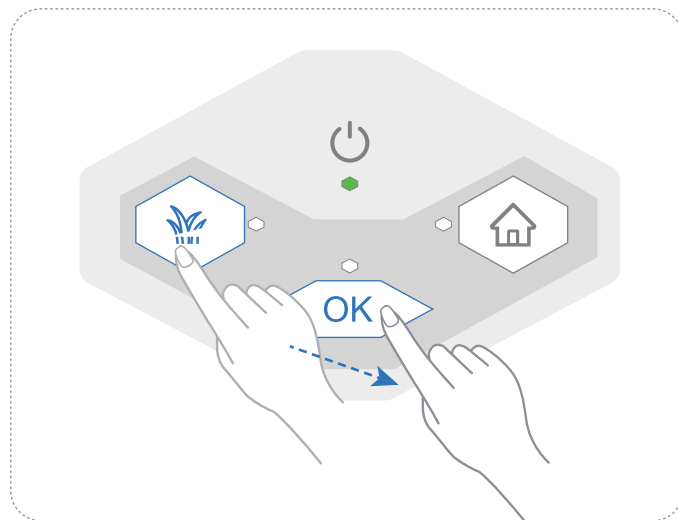
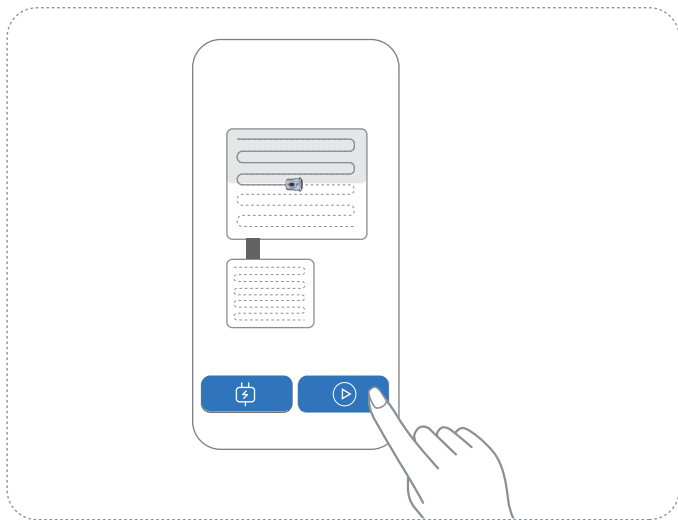

Returning To The Charging Station

Press HOME+OK on the button panel of lawn mower in sequence, or click Home on the App.

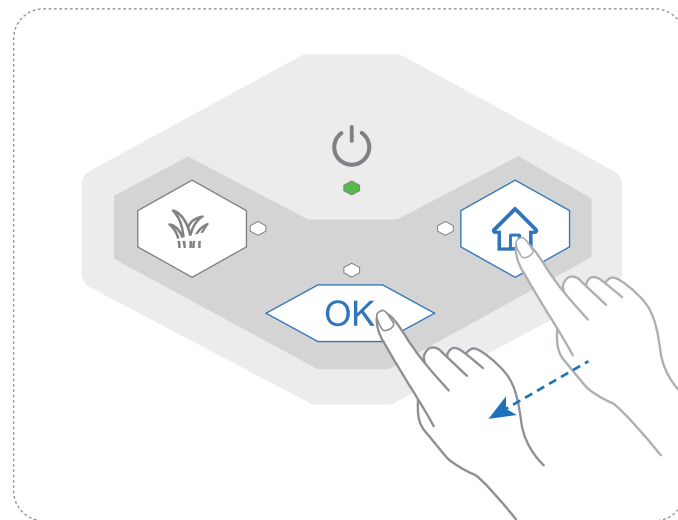
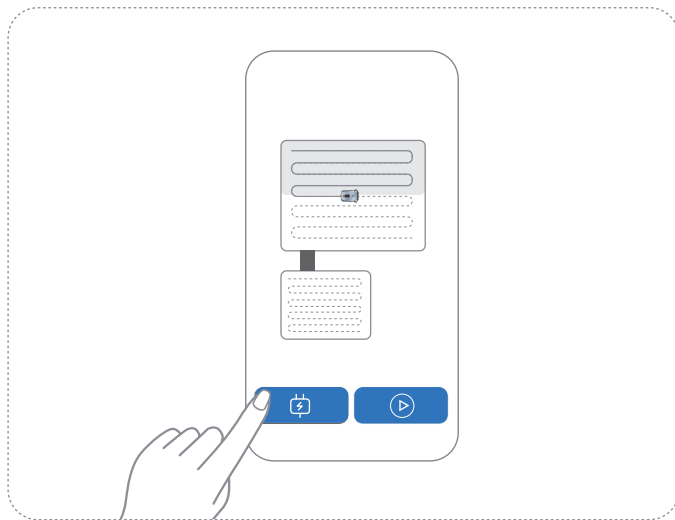

Release The Abnormal State

When some events that may affect the safety or mowing are detected, the lawn mower will be in an abnormal state, accompanied by a red LOGO light, you then need to log in to the App to check the abnormalities on the mower. For the abnormalities that can be manually restored, operate as follows: short press OK button to release the abnormal state. The indicator light will not be red when the abnormality is resolved.

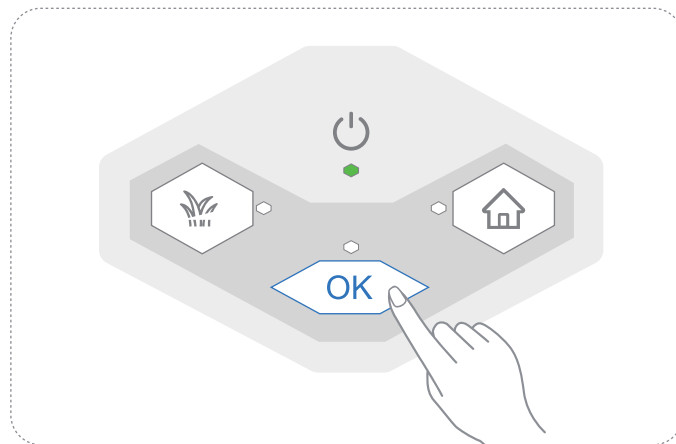
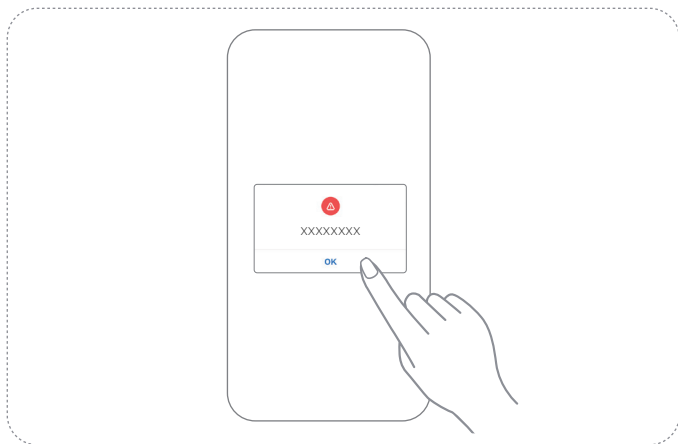

CAUTION:

In addition to the recovery methods indicated on the App for abnormal events that you can manually recover on your own, the button lights on the button panel will also guide you to recover anomalies.

4.5 Other Functions

In addition to the App functions mentioned in the above chapters, including adding lawn mower, mapping, and viewing and controlling mower operation, you can also:

- (1) View and change the work settings of lawn mower (map management, scheduled tasks, mowing parameter settings, etc.)
- (2) Activate the visual obstacle avoidance function so that the lawn mower can visually recognize and avoid obstacles during automatic mowing.
- (3) Activate the patch mowing function, so that the lawn mower can record and perform patch mowing in the areas where obstacle avoidance function is activated during the automatic mowing process.
- (4) Complete configuration whether the lawn mower mows grass on rainy days.
- (5) Find the lost lawn mower (find the device).
- (6) Manage the permissions relating to the lawn mower.
- (7) View and upgrade the firmware of lawn mower.
- (8) Restore factory settings for the lawn mower.

Map Management

In order to cope with possible future changes to your yard's lawn, we provide map management function. In addition to creating a new map, you can also add, modify, and delete areas on a created map.

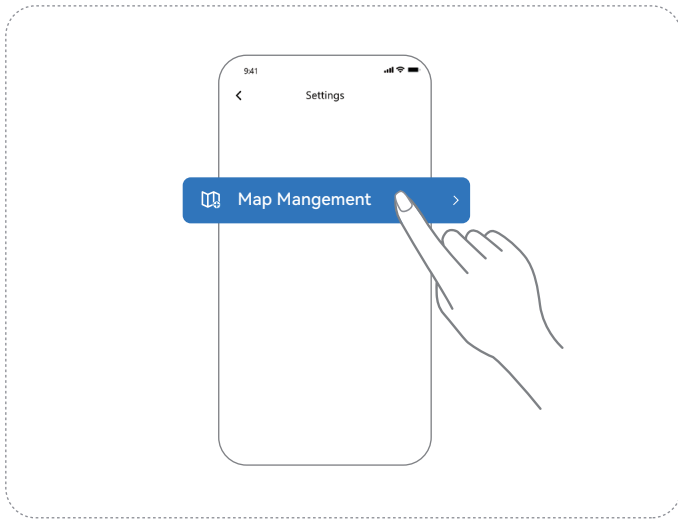

Scheduled Task

You can set a scheduled task for the lawn mower, and the lawn mower will automatically mow according to the scheduled time.

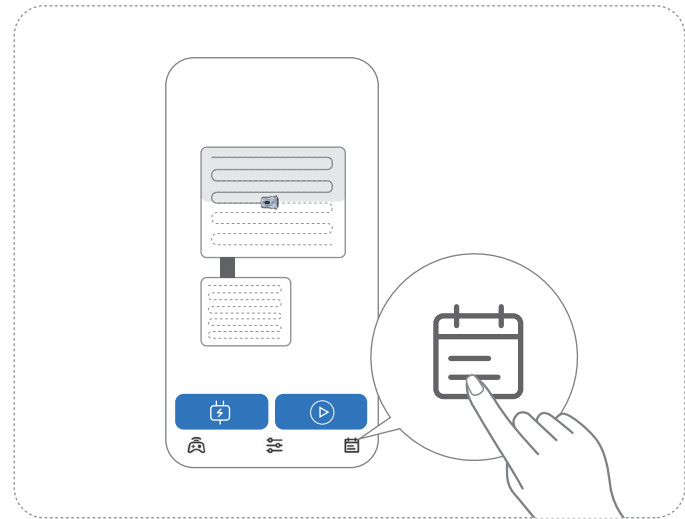

Mowing Parameter Settings

To ensure that you can flexibly adjust the mowing effect of lawn mower, you can set mowing related parameters on the App, such as mowing height, mowing angle, preset mowing mode, etc.

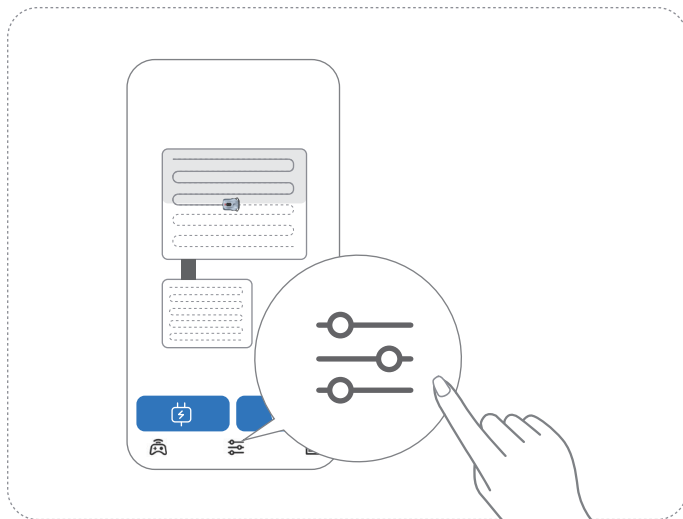

Visual Obstacle Avoidance

In order to provide precise obstacle avoidance so that the lawn mower can accurately identify low obstacles in front during automatic mowing, we have turned on the visual obstacle avoidance switch, which can be turned on or off as needed. It is advisable not to enable visual obstacle avoidance when mowing at night, as this may lead to a poor visual recognition.

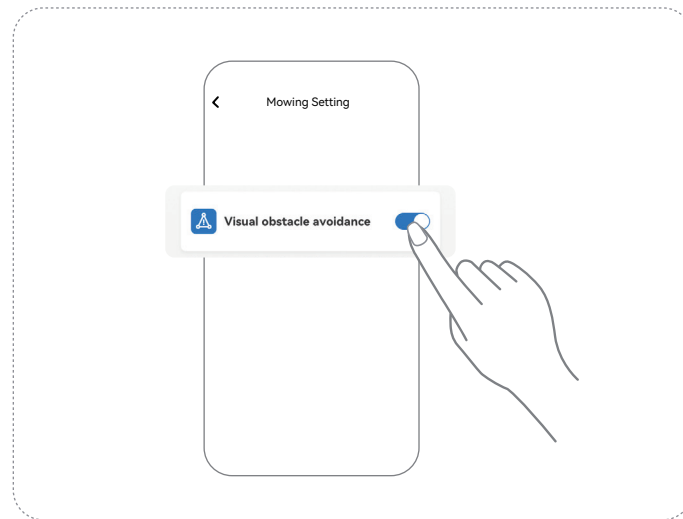

Patch Mowing

In order to reduce mowing omission and increase mowing area during mowing process, we provide the patch mowing function. In the case where the mower fails to mow the lawn due to obstacle avoidance, the lawn mower will automatically return to the omission area after mowing a certain area as long as the patch mowing function is enabled.

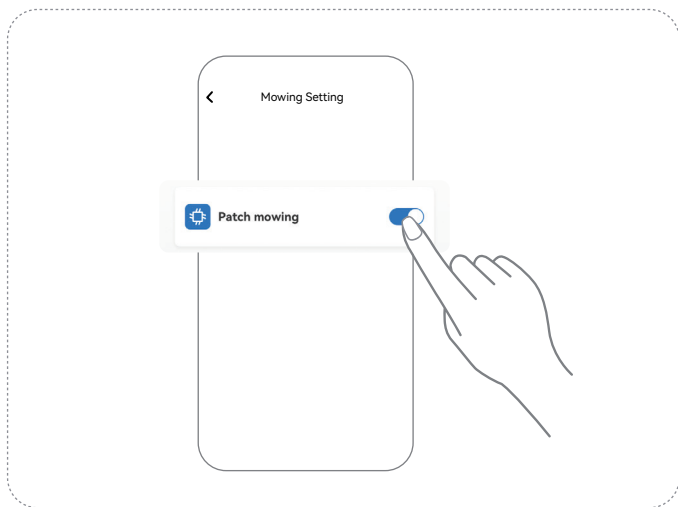

Find The Device

You can find the mower by this function when your mower is lost.

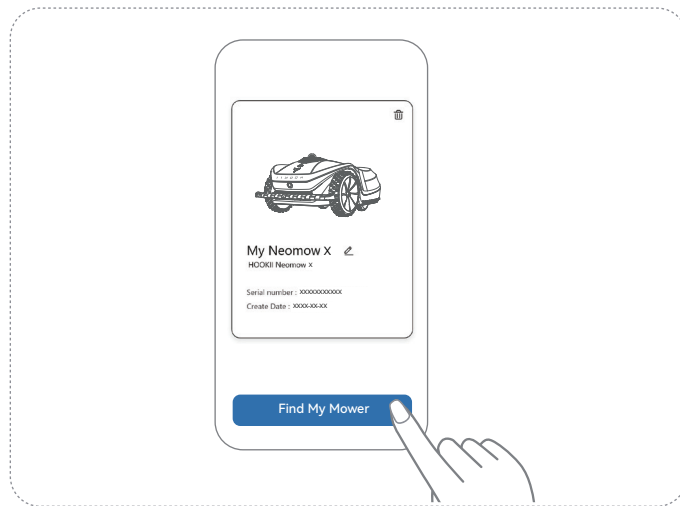

CAUTION:

By default, the GPS function is disabled for the lawn mower. GPS position information collection will only be enabled when you manually turn on this function to find a device, indicating that you can enjoy carefree use experience since the position information of the lawn mower normally will not be exposed.

Rainy Day Working

When working on a rainy day, the lawn mower will make judgment through a rain sensor, determine whether to continue mowing on the rainy day based on your settings on the App. By default, the lawn mower will not work on rainy days and would return to the charging station. The lawn mower, however, will continue mowing in the next time period with scheduled tasks, or after the user manually triggers the mowing operation.

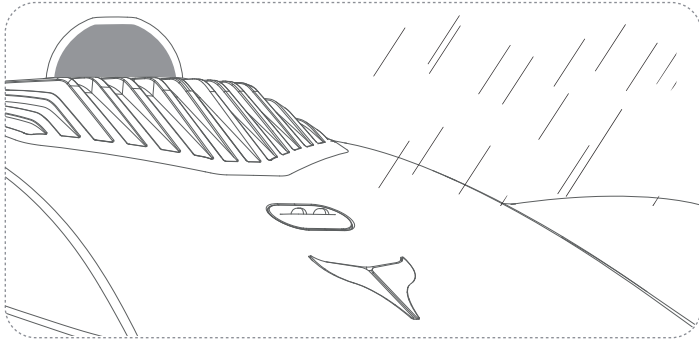

CAUTION:

It is recommended to maintain the default option, that is, No Mowing on Rainy Days, as mowing on rainy days will make it difficult to remove the grass and soil sticking to the blade disc or tires, causing the lawn mower to skid. Do not operate the lawn mower in harsh weather such as thunderstorms.

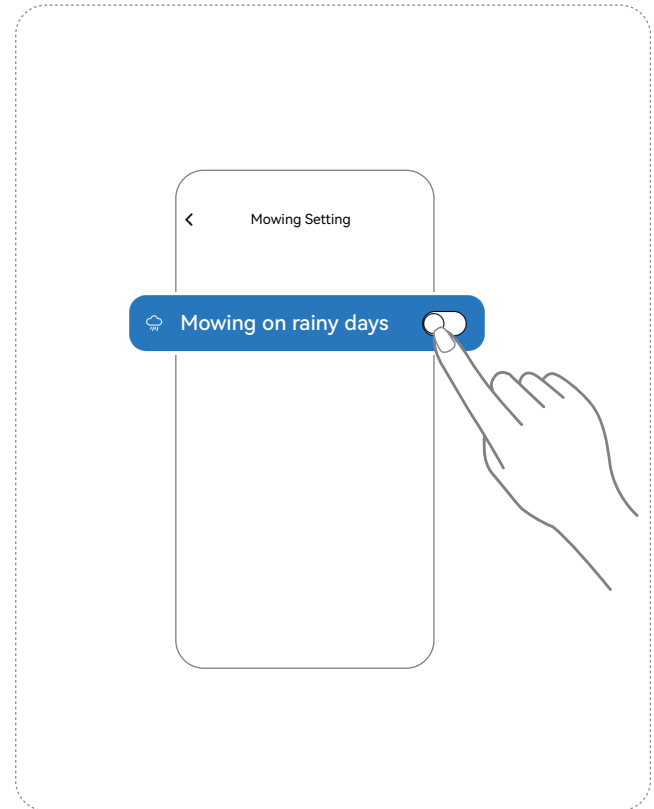

Device Sharing

To protect your lawn mower from unauthorized use and ensure the safety of your property, we design permission function for the lawn mower.

- (1) The account of initially bound device is the administrator of the lawn mower, who can share the device's usage permission with other accounts, for example, your family members.
- (2) Other users without shared device usage permission cannot connect to the lawn mower and to view the operations.
- (3) The administrator can manage the permissions currently shared.

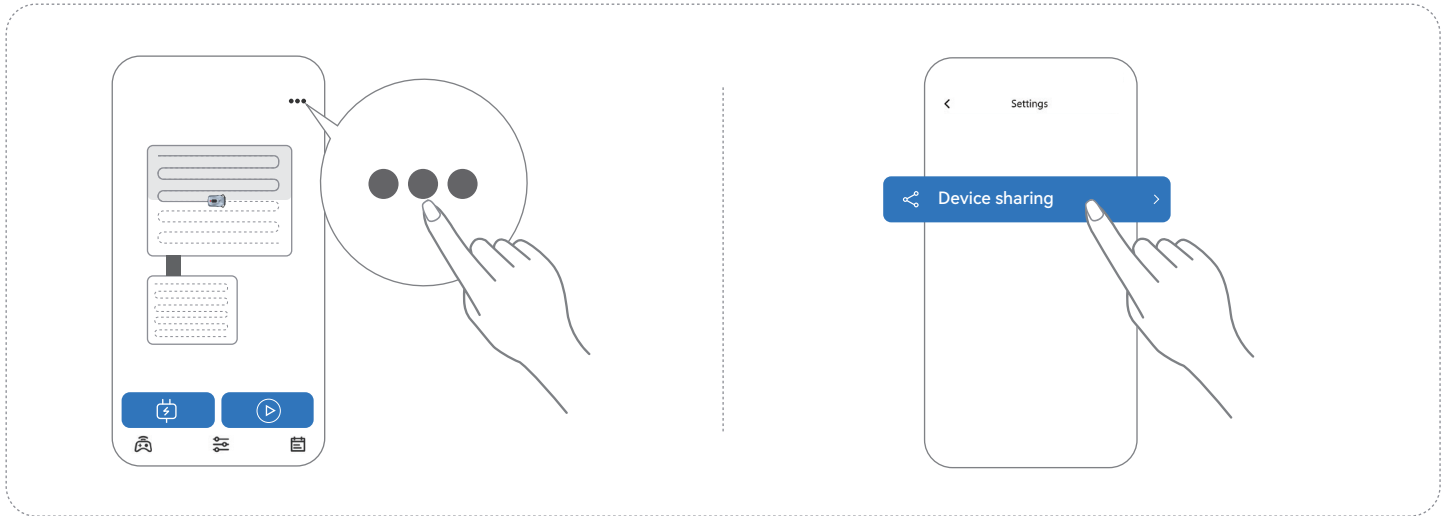

Firmware Upgrade

We will continue to update the features and firmware of Neomow X. In order to enjoy a better experience of the features, we suggest that you check for firmware updates regularly on the App, and we will also inform you of any new firmware updates on the App.

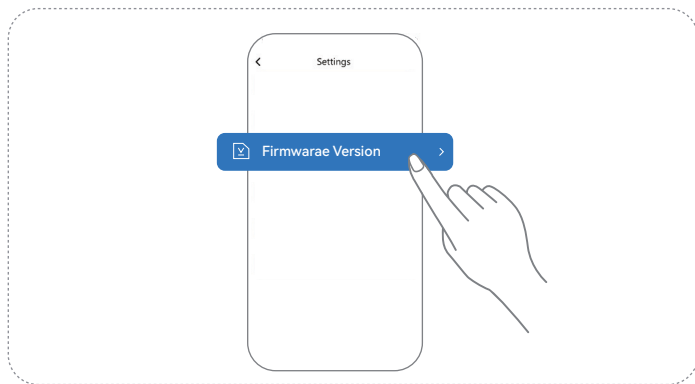

CAUTION:

- (1) The following conditions must be met prior to firmware update:
 - 1) The lawn mower is in a place with good WiFi networking condition and maintains a stable network connection.
 - 2) The lawn mower has sufficient battery life.
- (2) The LOGO light on the lawn mower will flash white during update, and you can check the update progress on the App.
Do not shut down during upgrade.

Restore To Factory Settings

In order to help you restore the device's settings and data to the default state, we provide the function of restoring to factory settings.

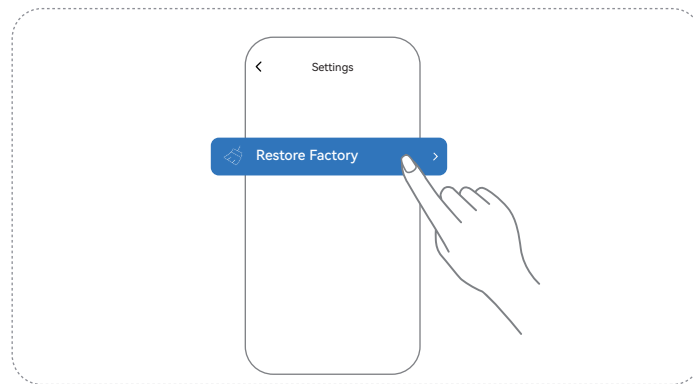

CAUTION:

- (1) Restoring to factory settings will clear data such as maps, mowing parameters, and scheduled tasks, other than permission related data. The administrator and other shared users can still bind the device.
- (2) Restoring to factory settings must be implemented at the charging station. Prior to the operation, move your lawn mower to the charging station.
- (3) Only the administrator has the authority to restore to factory settings.

4.6 Obstacle Avoidance

The Neomow X obstacle avoidance system, composed of three parts: obstacle avoidance by LiDAR, obstacle avoidance by visual recognition, and collision avoidance by bumper, covers a detection range in multiple directions and large angle, and can develop reasonable and efficient obstacle avoidance strategies to protect your property and personal safety.

- (1) When detecting an obstacle in front during operation in the mowing area, the lawn mower will avoid the obstacle along a path at least 10cm away, and then return to the original mowing track to continue working.
- (2) When the lawn mower cannot pass through the passage or recharge path due to obstacles, it will stay in place and wait for the obstacles to be removed before movement or continue to work in the barrier-free zone, depending on the actual condition.

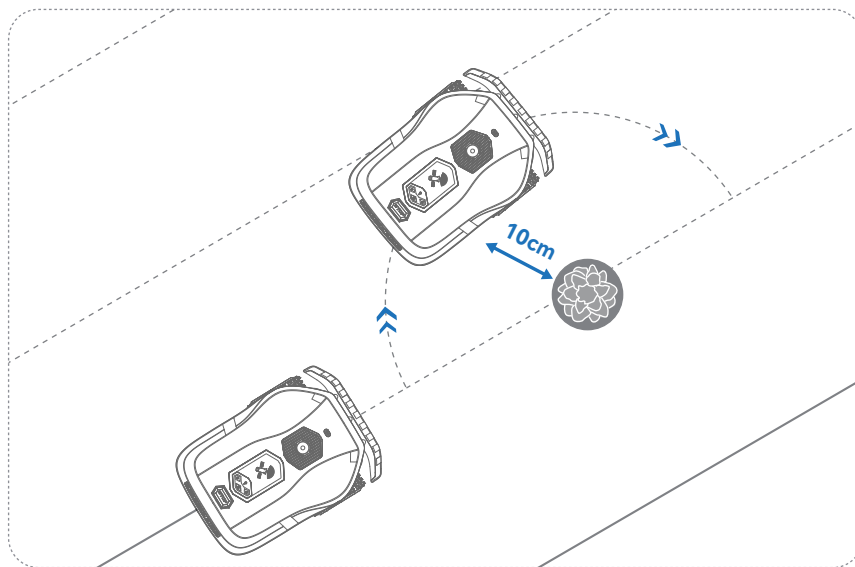

CAUTION:

When working at night, turn off the visual obstacle avoidance switch of the lawn mower, otherwise it may cause visual recognition errors that affect the normal operation.

5.1 Lighting Guidance

HOOKII LOGO Light

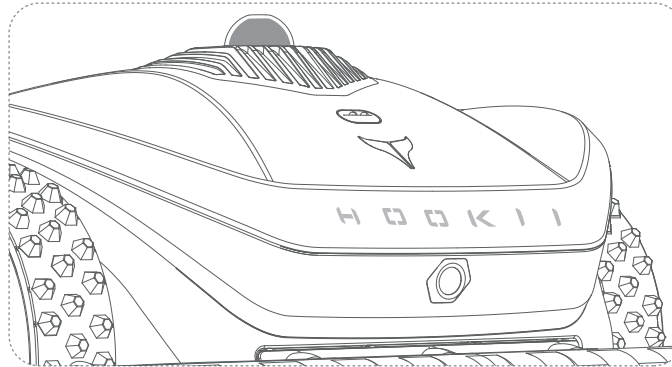

Blue light breathing	Starting up
Blue light always on	Normal operating state or in sleep state
Green light breathing	The mower is being charged at the charging station but not fully charged.
Green light always on	The mower is fully charged on the charging station
Red light always on	An abnormal event occurred with the mower
White light breathing	The mower is being upgraded

Lighting For The Button Panel

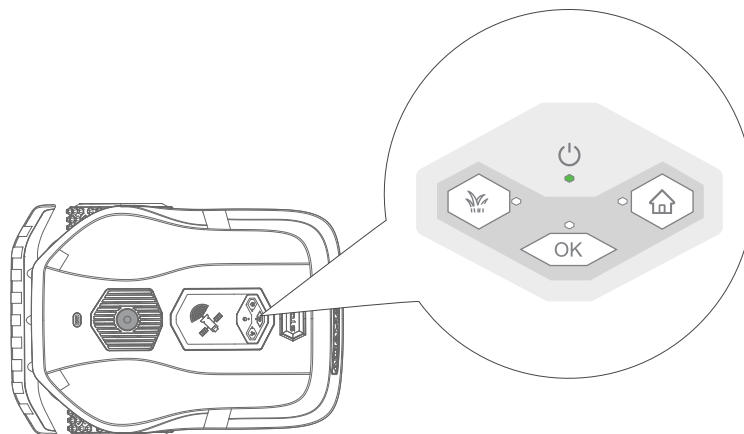

OK indicator light flashes green

When you press Mow but not OK button
or press HOME but not OK button
or when an abnormal event that you can restore on your own occurs on the lawn mower

Lighting For The Charging Station

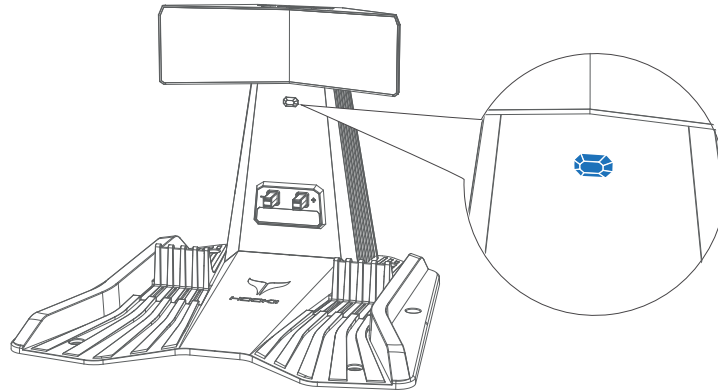

Indicator light for the charging station	OFF	The charging station is neutral
	Blue light always on	The charging station is electrified but the lawn mower is not being charged at the station
	Green light always on	The charging station is electrified and the lawn mower is being charged at the station

5.2 Sound Reminder

The lawn mower will provide sound reminder in case of any state change, and the lawn mower may have abnormalities when the sound reminder continues. You should log in the App to view specific abnormality information and handling methods.

6.1 Frequency Of Maintenance

- (1) The lawn mower must be shut down and powered off before any maintenance operations. And use protective gloves.
- (2) Regular lawn mower cleaning and replacement of worn parts are necessary in order to ensure lawn mower performance and extend lawn mower life. All cleaning and replacement operations must follow the maintenance recommendations provided by HOOKII.
- (3) The smoothness of blade disc, and the damage degree and service life of blades vary greatly in different conditions, for example, depending on the type of grass and season, the hardness of soil, and unexpected collision with other objects on the lawn. It is advisable to check and clean the blade disc once a week since blunt blades have too poor mowing efficiency to trim the grass completely.
- (4) It is advisable to inspect and clean once a week the components such as blades, blade disc, wheels, LiDAR, camera, and rain sensor. (Cleaning frequency should be increased in the case of rainy days or muddy ground).
- (5) To avoid work interference caused the LiDAR, in the case of humid weather, it is advisable to check the LiDAR for fog and stains before daily mowing in the morning.

6.2 Lawn Mower Cleaning

- (1) The lawn mower must be powered off before all maintenance operations in which the mower body needs to be raised and flipped over.
- (2) To prevent damage to electronic components, do not directly wash the lawn mower or charging station with a high-pressure water gun.
- (3) Housing of mower: Clean the exterior of lawn mower thoroughly with a soft brush or cloth. Alcohol, gasoline, acetone, or other corrosive/volatile solvents cannot be used for cleaning, as these substances may damage the appearance and internal structure of the lawn mower.
- (4) Charging station: Regular inspection on the charging station and removal of debris and soil are necessary for proper docking. All extension cables of the charging station and connecting components of power supply must not be blocked. The charging station must be powered off prior to the removal of dirt or other objects on the charging station.
- (5) The conductive pins of charging station: If the conductive pins are dusty, corroded or oxidized, the cleaning steps are as follows:
 - 1) Turn off the power to the lawn mower and charging station before performing maintenance operations to avoid short circuits or electric shocks.
 - 2) Wipe the conductive pins with a soft cloth or paper towel dipped in alcohol.
 - 3) Make sure the conductive pins are dry before turning on the power for use.
 - 4) Clean at least once every two weeks.
- (6) Chassis and blade disc: The dirty chassis and blade disc can be cleaned as follows:
 - 1) Press and hold the ON/OFF button until the LOGO light goes out and the lawn mower is shut down.
 - 2) You can see the chassis after flipping the lawn mower to one side (Note: Avoid placing it upside down). Place the mower on a soft cushion before flipping.
 - 3) Wash the blade disc and chassis with a water pipe (Do not wash directly with a high-pressure water gun) or brush them with a soft brush.

- 4) Check the blade disc for free rotation, while check the blades for free movement on the blade shaft and for obvious damages.
- (7) Wheels: Mud left on the wheels will affect the climbing slope during mowing.
 - 1) Turn the mower on its side (note: avoid placing it upside down) and use a plastic scraper to remove mud or other objects from the wheel surface to ensure the wheel traction.
- (8) The LiDAR, camera, and rain sensor should be cleaned as follows:
 - 1) Press and hold the ON/OFF button until the LOGO light goes out and the lawn mower is shut down.
 - 2) Gently wipe the exposed part of sensor or the lens surface of camera with a damp cloth or tissue until the sensor surface is free of dust or other dirt.
 - 3) After cleaning, wipe dry the sensor and camera to remove water stains.

6.3 Replacement Of Consumables

Replacing The Blade

To ensure safety and better mowing efficiency, it is advisable to replace the blades and screws once every 3–6 weeks. All five blades and their screws should be replaced simultaneously.

CAUTION:

- (1) **Wear thick gloves when inspecting or repairing blades.**
- (2) **Replace only with the blades and screws recommended by HOOKII to prevent safety accidents caused by incompatibility. Personnel involved in safety accidents due to the use of incompatible blades must bear the consequences themselves.**
- (3) **Do not reuse screws as aging screws may cause serious safety accidents.**
- (4) **It is advisable not to replace blades by using electric tools, such as electric screwdrivers, which may cause hand injury due to blade rotation.**

Method Of Replacing Blades

- (1) Press and hold the power on/off button until the LOGO light goes out and the lawn mower is shut down.
- (2) Make the mower edge on (Note: Avoid placing it upside down) and place it on a soft and clean surface to prevent surface scratch.
- (3) Loosen the five screws using a Phillips screwdriver.
- (4) Remove screws and blades.

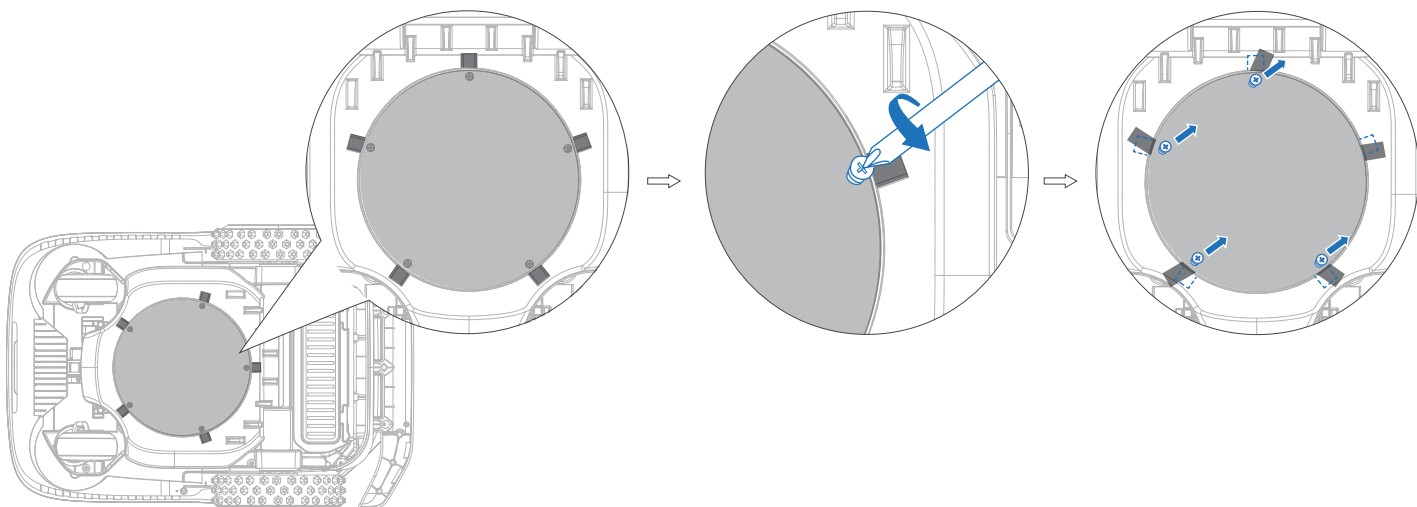

⑤ After tightening the screws, check and ensure that the blade can move back and forth flexibly.

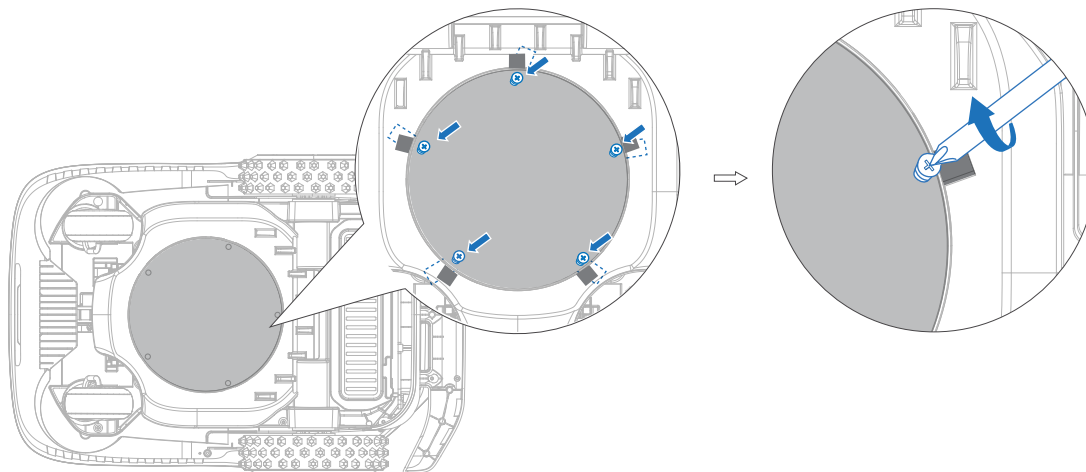

Replacing The Battery

- ① Press and hold the ON/OFF button until the logo light goes out and the lawn mower is shut down.
- ② Invert the mower and place it on a soft and clean surface to prevent surface scratch.
- ③ Loosen the 6 screws on the battery compartment using a Phillips screwdriver.

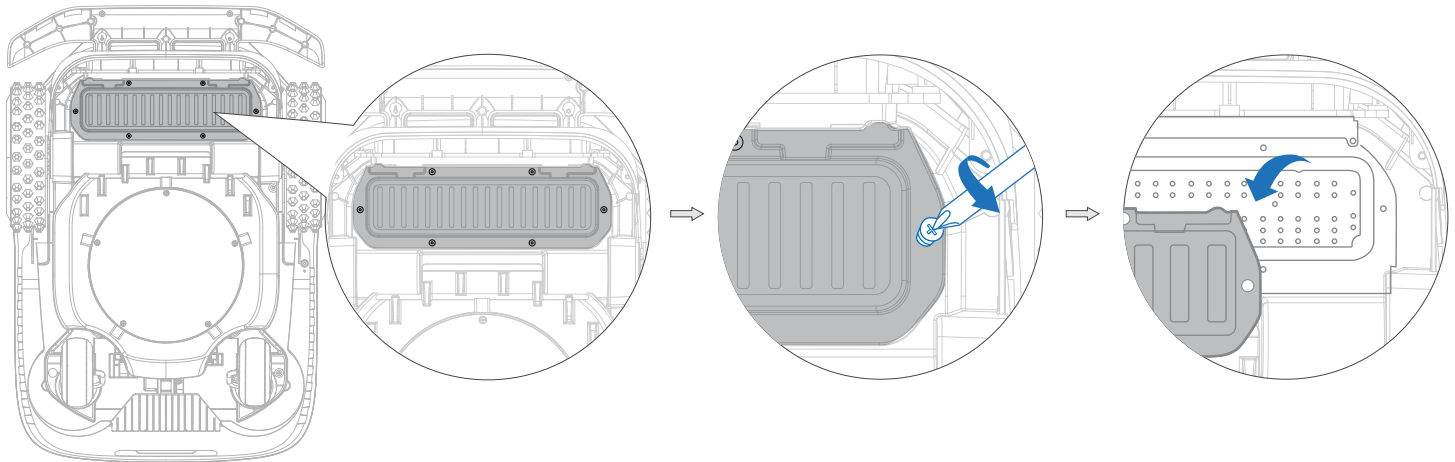

- (4) Disconnect the connection port.
- (5) Take out the battery pack and replace with a new one.
- (6) Connect the plug and tighten all screws.

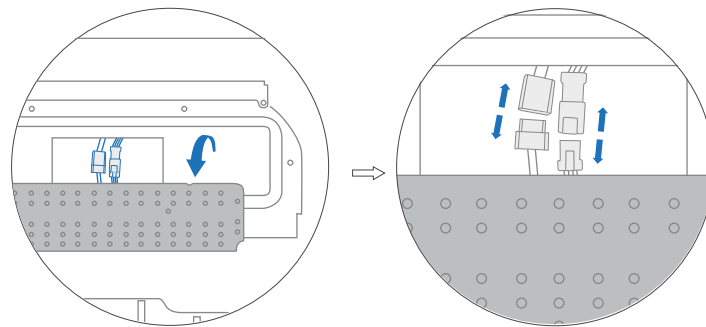

CAUTION:

- (1) Replace only with the batteries recommended by HOOKII to prevent safety accidents caused by mismatch. Personnel involved in safety accidents due to the use of incompatible batteries must bear the consequences themselves.
- (2) It is advisable not open the battery compartment frequently, which should be opened only when you need to replace the battery.
- (3) The battery life depends on the frequency of use and total working time of the lawn mower. The battery should be replaced if it has the running time significantly shorter than usual or the lawn is not properly trimmed when the battery is fully charged.
- (4) Warning: The original battery pack or the battery pack of same model specified by HOOKII must be used. Each lawn mower contains a battery pack.
- (5) Do not dismantle or pierce the battery casing. Keep the battery away from metal objects to prevent short circuits, and keep it away from fire, heat, and direct sunlight.
- (6) The battery pack contains electrolytes. If the leaked electrolyte comes into contact with your skin, wash with soap and water immediately; in the case of eye contact that causes discomfort, seek medical assistance.

7 SPECIFICATIONS

EN

	Name	Neomow X Lite	Neomow X	Neomow X Pro
Basic Information	Brand	HOOKII		
	Model	X-3EB10	X-1EB10	X-2EB10
		X-3NB10	X-1NB10	X-2NB10
		X-3AB10	X-1AB10	X-2AB10
	Mowing Robot Dimensions	729 x 508 x 338mm		
	Net Weight	17.1kg		17.5kg
	Charging Station Dimensions	520 x 514 x 338mm		
	Charging Station Weight	2.6kg		
	Package Weight	27.1kg		27.5kg
	Materials	Materials: Plastic and aluminum alloy		
Mowing Parameters	Mowing Size	Up to 2000 m ² (0.5 Acre)	Up to 4000 m ² (1 Acre)	Up to 6000 m ² (1.5 Acre)
	Mowing Time on One Full Charge	120min	120min	180min

7 SPECIFICATIONS



	Name	Neomow X Lite	Neomow X	Neomow X Pro
Mowing Parameters	Mowing Area per Charge	Up to 700m ² per charge		Up to 1000m ² per charge
	Cutting Width	28cm (11in.)		
	Cutting Height	30mm-85mm(1.2in.-3.3in.)		
	Navigation Mode	Lidar-SLAM+Camera		
	Working Conditions	Working Temperature	0-45°C, 10-35°C (50-95°F) recommended	
Working Conditions	Storage Temperature	-20-60°C , 0-35°C (32-95°F) recommended		
	Charging Temperature	0-45°C , 10-35°C recommended		
	Discharging Temperature	-20-60°C, 0-45°C (32-113°F) recommended		
	Waterproof Level	Mower body IPX5;		
	Max. Incline	24°(45%)		
Connectivity	Bluetooth® Frequency Range	2402.0-2480 MHz		
	Wi-Fi Frequency	2.4GHz ~2.4835GHz 5.1GHz ~5.85GHz		

7 SPECIFICATIONS

	Name	Neomow X Lite	Neomow X	Neomow X Pro
Connectivity	Cellular Network	America: LTE FDD: B2/4/5/12/13/17/66 Europe: LTE FDD: B1/3/5/7/8/20/28 LTE TDD: B38/40/41		
	Driving Motor	Motor Type	Brushless motor	
Blade Motor	Motor Type	Brushless motor		
Battery Pack	Battery Type	Lithium-ion battery		
	Nominal Voltage	18VDC		
	Nominal Capacity/Energy	13Ah/234Wh	13Ah/234Wh	17.5Ah/315Wh
	Battery Management System	Over-heating, short circuit, over-current, over voltage, and over-charge protection		
Power Supply	Input Voltage	100–240 VAC, 50~60Hz		
	Output Voltage/Current	21.5VDC/5A	21.5VDC/5A	21.5VDC/8A

Charging Station	Input Voltage/Current	100-240 VAC,50~60Hz		
	Output Voltage/Current	21VDC/5A	21VDC/5A	21VDC/8A
Others	Noise Level	<60 dB(A)		
	Front Wheel	Rubber tyres with brushless motor		
	Rear Wheel	Omni-directional wheel with built-in Hall sensor		
Others	Sensors	Lidar, Camera, IMU Sensor, Blade Halt Sensor, Bump Halt Sensor, Wheel Halt Sensor, Rain Sensor		

NOTE:

- (1) The above parameter data based on the laboratory are for reference only.
- (2) HOOKII reserves the right to make changes without prior notice. If you'd like to know the latest lawn mower information, visit our official website at www.hookii.com.

Troubleshooting

A quick search table for common problems with the lawn mower is presented below, which can help you identify problems. In the case of any problems with the lawn mower, check the information in the table and try to solve them by yourself. If the problems are still not resolved, contact HOOKII after-sales service team via support@hookii.com.

Problem	Possible Cause	Solution
The lawn mower fails to start up	Low battery	Charge lawn mower on the charging station to charge, and restart after it is fully charged.
The lawn mower is not charged on the charging station or automatically shuts down.	<ol style="list-style-type: none"> (1) The charging station is not properly connected to the power supply (2) The stains at the charging pad of the lawn mower connected to charging station result in poor contact. (3) Too high/low battery temperature results in battery protection (4) Battery over-discharge 	<ol style="list-style-type: none"> (1) Connect the charging station to the power supply. (2) Check for dirt and clean the charge pad. (3) Try charging again when the lawn mower returns to normal temperature. (4) Contact HOOKII after-sales service team.
WiFi connection fails for the lawn mower	<ol style="list-style-type: none"> (1) The lawn mower is too far from the router (2) The WiFi frequency band supported for the lawn mower is inconsistent with that used by the router 	<ol style="list-style-type: none"> (1) Keep the lawn mower near the router. (2) Check the WiFi frequency band parameters supported for the lawn mower and match the router frequency band through adjustment.

Problem	Possible Cause	Solution
Abnormal 4G network for the lawn mower	(1) The place where the lawn mower is located has poor 4G network signal (2) 4G data plan has amount overdue	(1) Keep the lawn mower in an area with good 4G network signal. (2) Top up data plan.
I can't bind this lawn mower	You are not an administrator, and the administrator does not share usage permission with you	Contact the administrator to share usage permissions
My App can't connect to the lawn mower	(1) The lawn mower is shut down (2) The lawn mower shows network abnormality	(1) Start lawn mower and reconnect it (2) Check the lawn mower for network connection, such as whether 4G has amount overdue and whether the connected WiFi is normal.

Problem	Possible Cause	Solution
<p>The lawn mower remotely controlled by the App doesn't respond during mapping</p>	<ul style="list-style-type: none"> (1) A too large distance from the lawn mower results in unstable Bluetooth signal (2) There are large and high obstacles between them during mapping process. 	<ul style="list-style-type: none"> (1) Keep close to the lawn mower within 6 meters as much as possible. (2) To avoid bluetooth disconnection during mapping, keep the phone and mower away from large obstacles, such as trees, high walls, houses, etc.
<p>The lawn mower cannot return to or exit the charging station normally.</p>	<ul style="list-style-type: none"> (1) The charging station deployed and the created recharge path do not comply with regulations. (2) There are obstacles on the charging station or recharge path. (3) The emergency stop button is pressed down, causing the failure of lawn mower to be automatically recharged (4) Someone is standing in front of the charging station when the mower is leaving. (5) The mower is not well positioned 	<ul style="list-style-type: none"> (1) The charging station should be deployed with an unobstructed space of 0.5m on the left and right side, 2m in front. The recharge path should have a minimum width of 77cm, otherwise, the location of recharge path and charging station should be changed. (2) Check for obstacles near the charging station and recharge path and if any, remove them. (3) Release emergency stop state (4) There should be no obstacles and people in front when the mower is leaving. (5) Move the lawn mower back to the charging station and reposition it

Problem	Possible Cause	Solution
The lawn mower fails to accurately align with the charging station during entry and exit	<ul style="list-style-type: none"> (1) The location of charging station is substantially moved after the map is created. (2) Water droplets and dirt on the radar sensor 	<ul style="list-style-type: none"> (1) Re-mapping is required if it is necessary to change the location of the charging station. (2) Check the radar sensor for water droplets and obvious dirt and if any, wipe clean timely.
The lawn mower cannot automatically mow the lawn	No mowing plan	Develop a suitable mowing plan on the App.
The lawn mower fails to perform tasks according to the set schedule	<ul style="list-style-type: none"> (1) Emergency stop button is being pressed (2) Low battery (3) Rain sensor is being triggered 	<ul style="list-style-type: none"> (1) Release emergency stop state (2) Charge the lawn mower to battery level larger than 80%. (3) The lawn mower will not go out to work by default as long as the rain sensor is triggered. You can change the rules on the App to enable mowing on rainy days.
There is a prompt for obstacles when the lawn mower is moving on the passage toward the next area.	<ul style="list-style-type: none"> (1) The mower identifies obstacles in the passage (2) The passage does not comply with rules 	<ul style="list-style-type: none"> (1) Check for obstacles near the charging station and recharge path and, if any, remove them. (2) The passage should have the minimum width of 77cm and, if not, the location of passage can be changed. If there is a wall near the passage, the passage should not be directly constructed against the wall.

Problem	Possible Cause	Solution
<p>The lawn mower has an irregular moving path in certain areas</p>	<p>There are obstacles in the area, and the lawn mower is steering clear of them.</p>	<p>The lawn mower will automatically adjust its movement mode and return to normal state.</p>
<p>The lawn mower shows positioning abnormality</p>	<ul style="list-style-type: none"> (1) Due to manual operation, the mower is located outside the boundary and is not on the mowing area or charging station. (2) The mower' s internal system shows a brief abnormality. (3) The lawn is too open to have any object of reference for the mower. 	<ul style="list-style-type: none"> (1&2) The mower can be transported to the interior of the mowing area by manual remote control or kept stationary on the charging station, and it will automatically restore its positioning. (3) Neomow X relies on LiDAR to detect features within a radius of 25m from the center of the mower to assist in positioning. Check if the work area of the lawn mower meets the condition, and if necessary, place features in an excessively open yard to assist in positioning.
<p>The lawn is mowed unevenly</p>	<ul style="list-style-type: none"> (1) The high and dense grass results in poor mowing efficiency. (2) The blades have become dull after a long time of use. (3) The blade disc or blades cannot rotate normally due to blockage. 	<ul style="list-style-type: none"> (1) Adjust the mowing height to a higher value, then gradually lower it to the desired height and cut grass in sequence. (2) Replace the blades. (3) Check the state of blade disc and clean it.

Problem	Possible Cause	Solution
<p>Some lawn areas are not mowed</p>	<ul style="list-style-type: none"> (1) The obstacles in this area results in mowing failure in part of the area. (2) An abnormality occurs while the mower is performing tasks in the area, and the lawn mower goes back for charging. 	<ul style="list-style-type: none"> (1) It is normal for the lawn mower to avoid obstacles during mowing process, which will result in mowing failure in certain areas. The mower will perform patch mowing afterwards. (2) Confirm the issue against the App and try to activate a new mowing task again.
<p>The lawn mower cannot cut grass or the blades stop rotating during mowing process</p>	<ul style="list-style-type: none"> (1) The lawn mower does not mow until it reaches the mowing area. (2) The lawn mower does not cut grass on the passage or recharge path. (3) Overcurrent protection for mower motor. (4) Other protective mechanisms are triggered (such as lifting, tilting, etc.) 	<ul style="list-style-type: none"> (1) It is normal (2) It is normal (3) In the case of long and dense grass, the lawn mower motor may have a too high current during operation or automatically stop rotating for self-protection. It is advisable to increase the mowing height or trim the lawn to below 10cm using other mowing tools. (4) Check the alarm state of device and clear the alarm by following the instructions.
<p>The lawn mower is stuck</p>	<ul style="list-style-type: none"> (1) The lawn mower cannot move because its wheels are stuck by long grass or mud. (2) The wheels are trapped in a deep pit on the lawn. (3) The soil in the trapped area is soft and the ground conditions are harsh 	<ul style="list-style-type: none"> (1) Check the wheels and remove any debris stuck on them. (2) Fill the pits on the lawn and keep the surface flat. (3) No-Go zones can be designed in this type of area for avoidance.

Problem	Possible Cause	Solution
Abnormal noise occurs during mowing process	<ul style="list-style-type: none"> (1) Blade passivation leads to increased cutting noise (2) Abnormal damage to the blade disc 	<ul style="list-style-type: none"> (1) Replace the blades. (2) Check the condition of blade disc, and contact a professional to replace the damage ones.
The lawn mower is stationary and the buzzer is beeping	Abnormalities occur to the lawn mower	View specific alarm information on the App and try to resolve the alarms according to the guidance. If the attempt fails, contact HOOKII's after-sales service team.
The lawn mower shows abnormal night working trajectory and is unable to avoid obstacles	Turn on visual obstacle avoidance at night	When the lawn mower is working at night, the visual obstacle avoidance switch should be turned off, otherwise the visual recognition errors will affect the normal operation of the lawn mower.
The lawn mower has a shorter endurance	<ul style="list-style-type: none"> (1) Battery aging (2) Impact of the lawn (such as long and dense grass, steep slopes, etc.) (3) Impact of different mowing modes (such as using power mode, etc.) 	<ul style="list-style-type: none"> (1) Replace the battery (2) It is normal (3) It is normal
I have authorized the lawn mower to upload its GPS information, but I did not see its location on the map on the [Find My Device] page	<ul style="list-style-type: none"> (1) It takes some time for the lawn mower has to upload GPS. (2) Network data is required for GPS information uploading, and the lawn mower shows network abnormality. 	<ul style="list-style-type: none"> (1) It is normal, and you can refresh the page (2) Check the lawn mower for network connection, such as whether 4G is overdue and whether the connected WiFi is normal.





ORCA INNOVATION TECHNOLOGY CO., LTD

 <https://hookii.com>

 info@hookii.com

 A29(13-29)VankeCloudCityPhase4(ConcentratedCommercialProject),Dashi1stRoad,
XiliCommunity,XiliStreet,NanshanDistrict,Shenzhen,China

 Customer Service
service@hookii.com

 Technical Support:
support@hookii.com